



the way to fish[®]

TABLE OF CONTENTS

DOWNRIGGERS

- 6 downrigger basics
- 6 compair downriggers
- 8 high performance
- 10 depthpower
- 12 manual
- 14 compact
- 16 laketroller

DOWNRIGGER MOUNTS

- 18 downrigger mounts
- 19 compact downrigger mounts
- 19 downrigger dual rod holder

DOWNRIGGER PARTS & ACCESSORIES

- 20 Seeker
- 22 parts & accessories
- 24 downrigger tackle
- 25 cable & line

LINE RELEASES

- 26 power grip plus
- 26 mini power grip plus
- 27 sure stop
- 27 snubber
- 27 weight retriever

LINE PULLERS

- 28 electric
- 28 manual
- 29 bait jars

ROD HOLDERS

- 30 striker
- 32 orca
- 34 power lock
- 36 rocket launcher
- 36 rodmaster
- 36 rodmaster II
- 37 side winder
- 38 R-5
- 40 baitcaster spinning
- 42 fly rod

MOUNTS

- 46 electronic mounts
- 48 transducer mounts
- 49 ball mounts
- 52 action camera boom
- 54 action camera mount
- 56 phone holder
- 58 tablet holder
- 60 post mounts
- 60 rail mount
- 62 adapters
- 62 low profile track
- 63 3" track accessories
- 64 gear head
- 65 locking gunnel track mount

ACCESSORIES

- 66 fishing accessories
- 67 bait board
- 67 triple mounting system
- 68 gear caddy
- 70 extensions & Adapters
- 72 boating accessories

PADDLE SPORTS

- 74 paddle sport accessories
- 74 kayak stabilizer
- 75 anchor lock
- 76 kayak accessories
- 78 kayak fishing starter pack
- 80 glue/stick on mounts

SAFETY EQUIPMENT

- 82 sea-light
- 83 pumps

JORDAN-SCOTTY

- 84 fish egg incubator systems



SCOTTY LOCATION

CANADA

UNITED STATES

SCOTTY FISHING & OUTDOOR PRODUCTS

2065 Henry Ave West
Sidney, British Columbia
Canada V8L 5Z6

Phone 250 656 8102
Toll Free 1 800 214 0141
Fax 250 656 8126
Email scotty@scotty.com

www.scotty.com
www.scottysfire.com

Scan the QR code to explore scotty products



LEGEND

- Water surface**
Best suited for still water
- Vessel recommendation**
Suited for paddle sports
- No assembly required**
- Factory and field tested**
- Colour options**

STAY CONNECTED



[scottysfishingproducts](https://www.facebook.com/scottysfishingproducts)

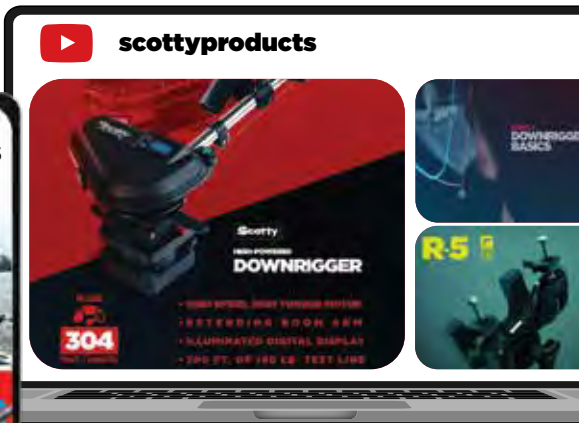
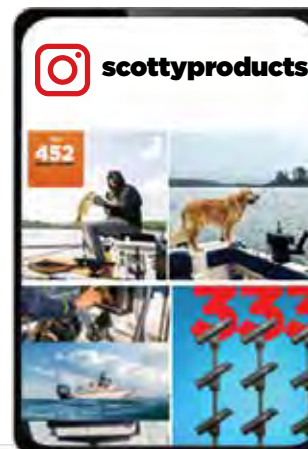

DOWNRIGGERS BASICS

WHY USE A DOWNRIGGER?

Deep water angling requires a different approach, and a different set of gear, than you would use fishing in rivers, streams, and other small bodies of water. And put simply, the reason is for depth. A downrigger is a device that's engineered to help you do just that.

DOWNRIGGERS IN 12 STEPS

STEP ONE

Mount the downrigger on your boat.

STEP TWO

Attach a weight to the downrigger line using the integrated clip and then attach a release clip to the downrigger line.

STEP THREE

Loosen the drag on your reel and then let out a length of line behind the boat.

STEP FOUR

Take the length of line from your reel and attach it to the downrigger release clip and then place the rod securely into your rod holder.

STEP FIVE

Now that the weight is securely attached to your downrigger line, carefully suspend the weight over the side of your boat.

STEP SIX

Slowly release the break by pulling back on the break handle. This will lower your downrigger weight into the water.

STEP SEVEN

When the weight has been lowered just beneath the surface of the water, let off the brake handle to stop the line descent and then attach your stopper beads to the downrigger line.

STEP EIGHT

While monitoring the depth measurement displayed on the depth counter, continue letting out the line until you have reached the desired depth.

STEP NINE

Now that we're at the right depth, let off the brake handle to stop the line descent.

STEP TEN

When trolling, it is best to minimize slack in the rod line. Tighten the drag on your reel. Reel in excess line until your rod bends into a fairly tight arc downward towards the water. We want to keep the rod in this position until we get a bite or we're ready to pack it in. Hopefully the former.

STEP ELEVEN

When a fish strikes the lure, we'll usually be able to see or hear a physical sign from the fishing rod. When we do, it's time to get ready! If the fish applies enough force, then it will release your line from the clip.

If the release clip is still in place, it's easy enough to disengage it—take the rod and move it in an upward motion until there's enough pressure for the line to be released.

STEP TWELVE

Now that we've got a fish on, we're going to turn on the auto stop on our downrigger. It's easy to get excited and forget this step, but it's important to do this. We don't want the downrigger line to become tangled with the fishing line.

Hitting auto stop will quickly retrieve the weight, and the stopper beads we placed earlier will ensure that the downrigger comes to a stop on its own—without any further attention needed—leaving us free to play the fish and get it on to the boat.

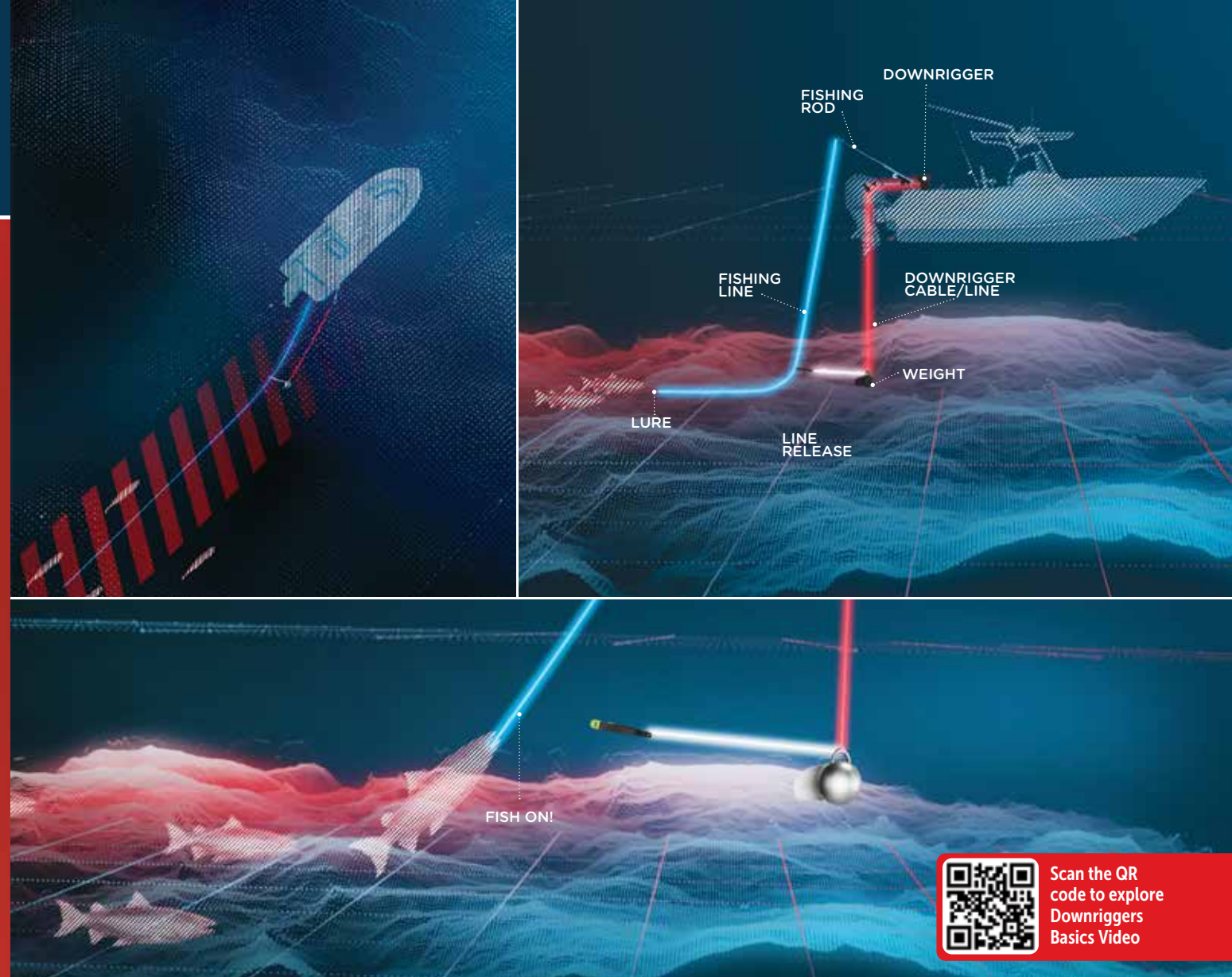

Scan the QR code to explore Downriggers Basics Video

COMPARE DOWNRIGGERS



HIGH PERFORMANCE

Electric



DEPTHPOWER

Electric



MANUAL

Manual



COMPACT

Manual



LAKETROLLER













Manual

POWER	HIGH PERFORMANCE	DEPTHPOWER	MANUAL	COMPACT	LAKETROLLER
BOOM LENGTH	36"-60" Telescopic	30" Fixed/36"-60" Telescopic	24" Fixed/36"-60" Telescopic	23" Fixed	12" Fixed
COUNTER TYPE	Digital	Mechanical	Mechanical	Mechanical	Not Applicable
WEIGHT CAPACITY	12-20 lb	7-15 lb	10-12 lb	7-10 lb	2-4 lb
WEIGHT STORAGE	Yes	Yes	Sold Separately	Not Applicable	Not Applicable
AMPERAGE DRAW	13-19.5 amps	4-8 amps	Not Applicable	Not Applicable	Not Applicable
AUTO STOP	Yes	Yes	Not Applicable	Not Applicable	Not Applicable

HIGH PERFORMANCE DOWNRIGGER

Scotty High Performance Electric Downriggers have reached the highest performance and reliability standards yet, while remaining competitively priced. Thousands of anglers now enjoy the superior speed, power and years of reliability that only Scotty offers. Scotty's custom designed marine components and final quality control tests produce a downrigger that is unmatched in the industry.

HIGH PERFORMANCE FEATURES

-  **LINE RELEASE**
Power Grip Plus 18" (1170)
-  **ROD HOLDERS**
Rod Master II 2106 & 2106B models (358)
Dual Rod Holders 2116 model (447)
-  **MOUNTS**
Tilt-up Mounting Bracket (1023)
Swivel Mount (1026)
Right Angle Marinco® Receptacle Mount (2128)
-  **AUTO STOP** (1121)
-  **4 AUTO STOP BEADS**
-  **WEIGHT STORAGE**
Storage Hook (1148)
-  **POWER SOURCE**
Marinco® 12V Plug & Receptacle (2125)
Power cord length, 40"
-  **DOWNRIGGER CABLE/LINE**
300 ft. of 180 lb. test stainless steel cable, 300 ft. of 250 lb. test braided line (2106B model)
-  **COUNTER**
Digital Illuminated LCD (2134)
-  **FACTORY & FIELD TESTED**
-  **FULLY ASSEMBLED**
-  **WARRANTY**
Limited Lifetime

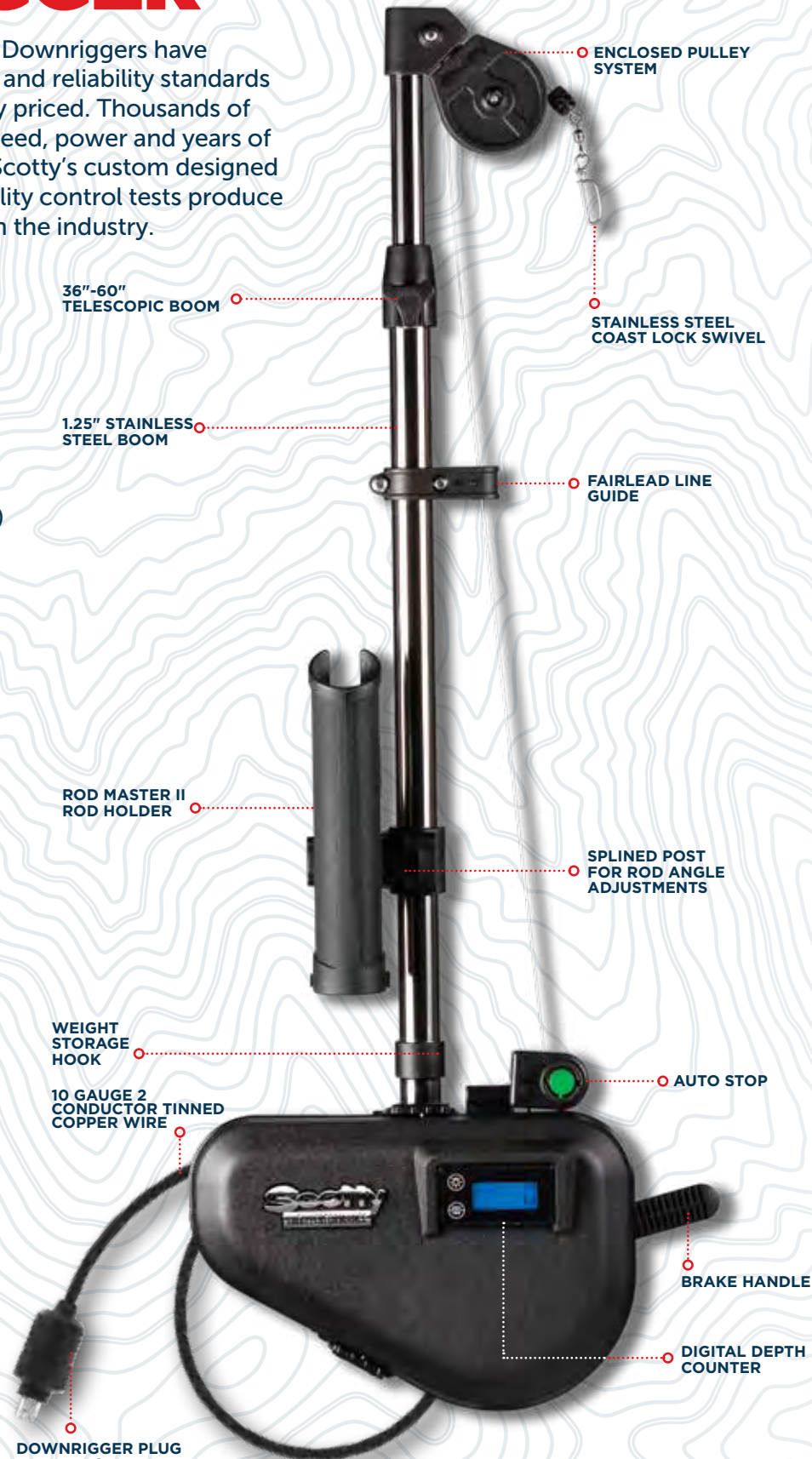

**2106
HIGH PERFORMANCE**
The downrigger of choice for serious fishermen. Unmatched in power, performance and reliability. Equipped with 300 ft. of 180 lb. test stainless steel cable. 36"-60" long 1.25" telescopic boom.

**2106B
HIGH PERFORMANCE**
Power and performance packaged with our strongest braided downrigger line. Equipped with 300 ft. of 250 lb. test braided line. 36"-60" long 1.25" telescopic boom.

**2116
HIGH PERFORMANCE
PROPACK**
The number one choice in performance downriggers for the charter captain. Equipped with 300 ft. of 180 lb. test stainless steel cable and our stainless steel rocket launcher dual rod holders. 36"-60" long 1.25" telescopic boom.















Scan the QR code to explore Downriggers

DEPTHPOWER DOWNRIGGER

Scotty Depthpower Electric Downriggers have the highest performance and reliability standards ever, while remaining competitively priced. Thousands of fishermen now enjoy the superior speed, power and years of reliability that only Scotty offers. From custom designed marine motors to the final quality control tests, Scotty performance is unmatched in the industry.

DEPTHPOWER FEATURES

-  **LINE RELEASE**
Power Grip Plus 18" (1170)
-  **ROD HOLDER**
Rod Master II (358) 1101, 1106 & 1106B models
Dual Rod Holder (247) 1116 model
-  **MOUNTS**
Tilt-up Mounting Bracket (1023)
Swivel Mount (1026)
Right Angle Marinco® Receptacle Mount (2128)
-  **AUTO STOP** (1121)
-  **4 AUTO STOP BEADS**
-  **WEIGHT STORAGE**
Storage Hook (1148)
(1106B & 1116 only)
-  **POWER SOURCE**
Marinco® 12V Plug & Receptacle (2125)
Power cord length, 40"
-  **DOWNRIGGER CABLE/LINE**
250 ft. of 150 lb. test stainless steel cable. 300 ft. of 200 lb. test braided line (1106B model only)
-  **COUNTER**
Mechanical (1145)
-  **FACTORY & FIELD TESTED**
-  **FULLY ASSEMBLED**
-  **WARRANTY**
Limited Lifetime

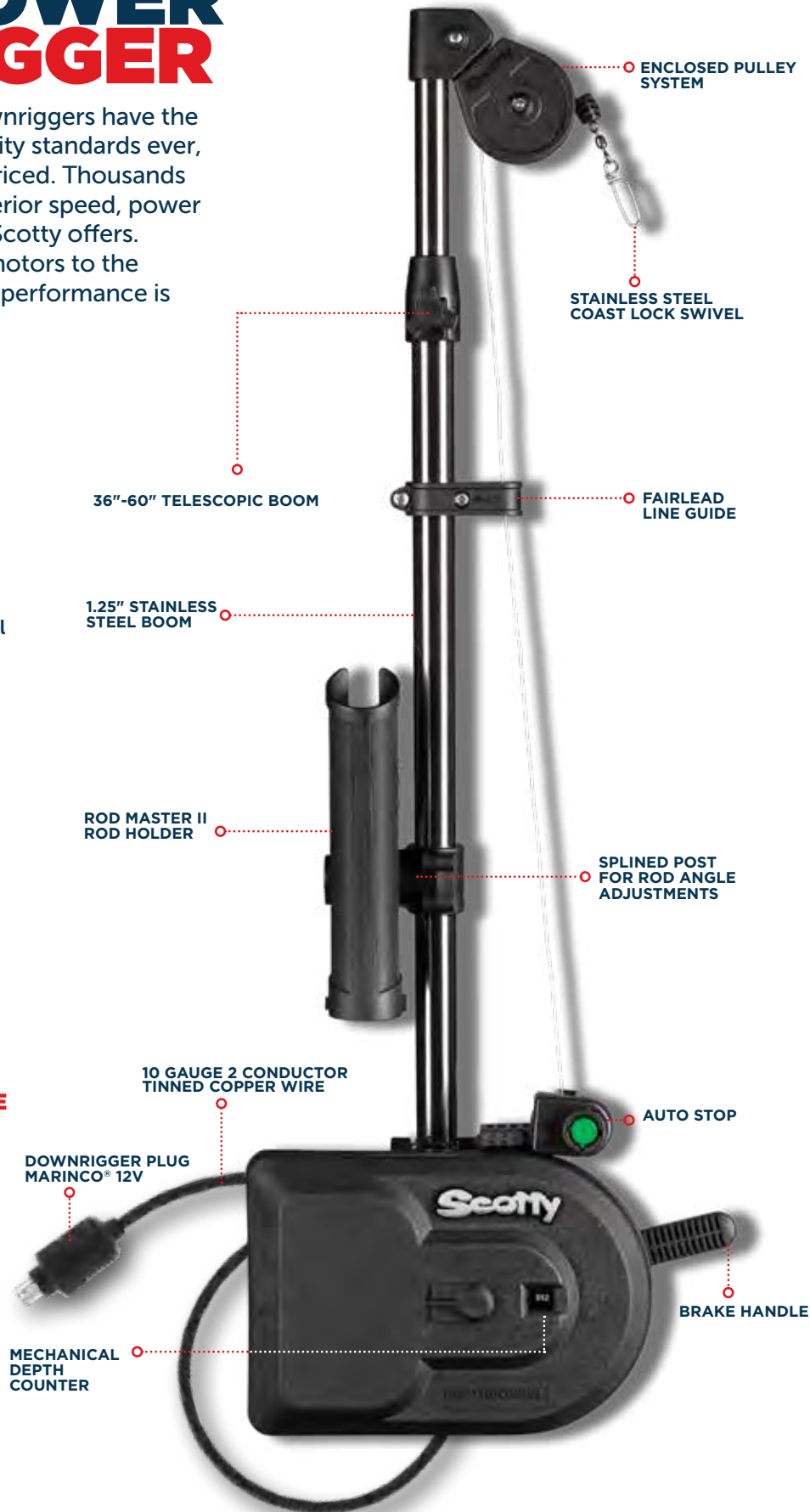

1101 DEPTHPOWER

Designed for heavy duty use, this unit will handle long hours and heavy weights in tough conditions. Equipped with 250 ft. of 150 lb. test stainless steel cable. 36"-60" long 1.25" diameter telescopic boom.



1106 DEPTHPOWER

Our most popular electric downrigger. Equipped with 250 ft. of 150 lb. test stainless steel cable. 36"-60" long 1.25" diameter telescopic boom.



1106B DEPTHPOWER

All the features you have come to love with our depthpower series. Now available with more options than ever. Equipped with 300 ft. of 200 lb. test braided line. 36"-60" long 1.25" diameter telescopic boom.



1116 PROPACK

The top choice of charter captains. Equipped with Dual Rod Holders (247). 250 ft. of 150 lb. test stainless steel cable. 36"-60" long 1.25" diameter telescopic boom.



3015 DOWNRIGGER COVER

Protect your downrigger from the elements with our downrigger protective cover.



MANUAL DOWNRIGGER

Scotty Manual Downriggers have been the preferred choice of anglers for over forty years. They are engineered with a number of exclusive features contained in no other downrigger.

MANUAL FEATURES

LINE RELEASE
Power Grip Plus 18" (1170)

ROD HOLDER
Rod Master II (358)

MOUNTS
Tilt-up Mounting Bracket (1023)
Swivel Mount (1026) 1091 model

DOWNRIGGER CABLE/LINE
200 ft. of 150 lb. test stainless steel cable

COUNTER
Mechanical (1146)

FACTORY & FIELD TESTED

FULLY ASSEMBLED

WARRANTY
Limited Lifetime

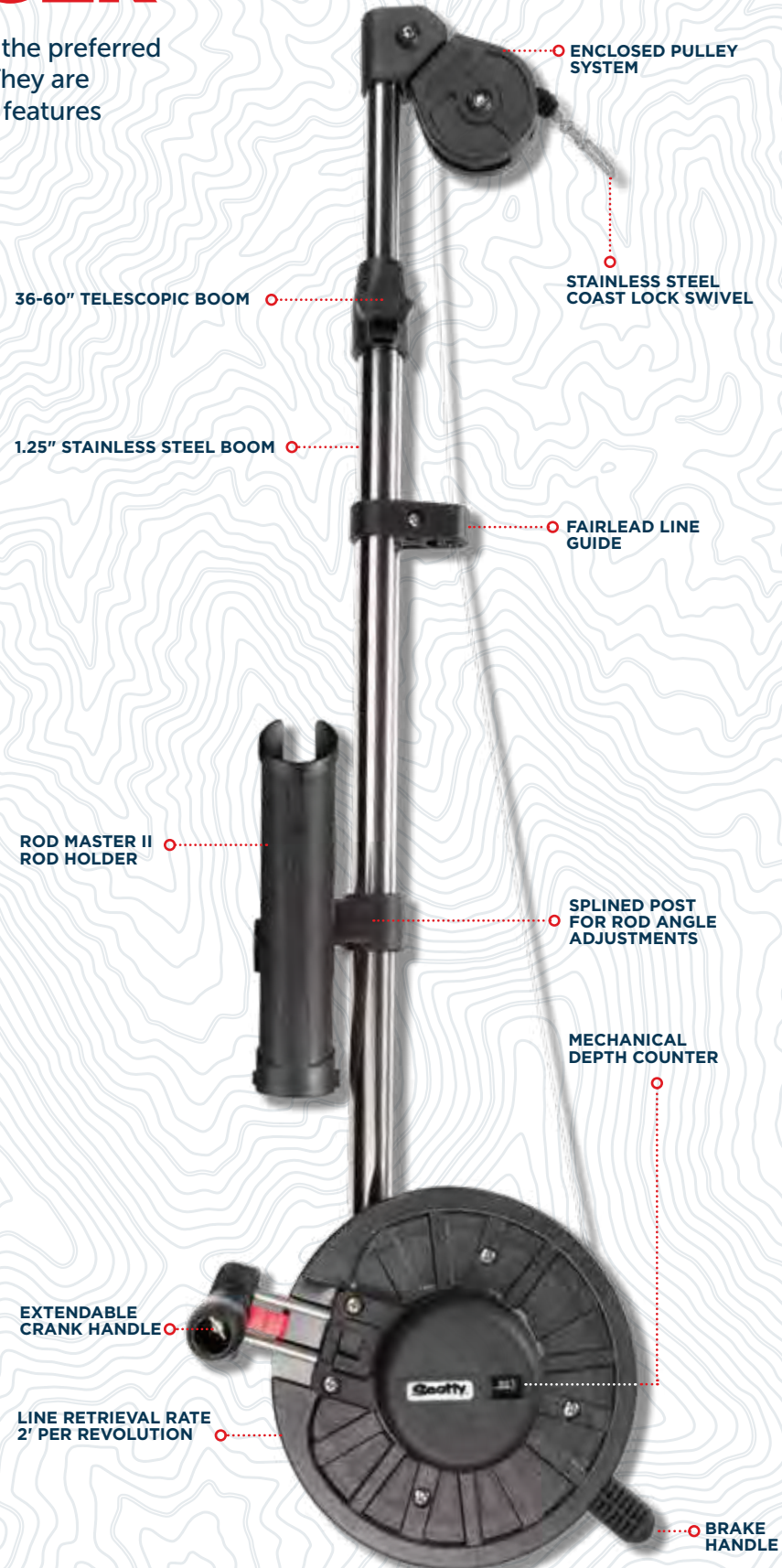

1085 STRONGARM

The heavy duty workhorse of the Scotty manual lineup. Excellent for the intermediate sized boat. Equipped with 200 ft. of 150 lb. test stainless steel cable. 30" long 1.25" diameter boom.

1091 LONGARM

Ideal for big boats. Equipped with 200 ft. of 150 lb. test stainless steel cable. 36-60" long 1.25" diameter telescopic boom. Includes 1026 Swivel Mount.



COMPACT DOWNRIGGER

The Depthmaster and Depthking models offer more value for the anglers than anything else on the market. The price and operating features of these units beat the competition hands down.

COMPACT FEATURES

-  **LINE RELEASE**
Power Grip Plus 18" (1170)
-  **ROD HOLDER**
Rod Master II (355)
-  **MOUNTS**
Quick-Slide Mounting Bracket (1010)
1050 and 1050MP models
Tilt-up Mounting Bracket (1023)
-  **DOWNRIGGER CABLE/LINE**
200 ft. of 150 lb. test stainless
steel cable
-  **COUNTER**
Mechanical (1146)
-  **FACTORY & FIELD TESTED**
-  **FULLY ASSEMBLED**
-  **WARRANTY**
Limited Lifetime

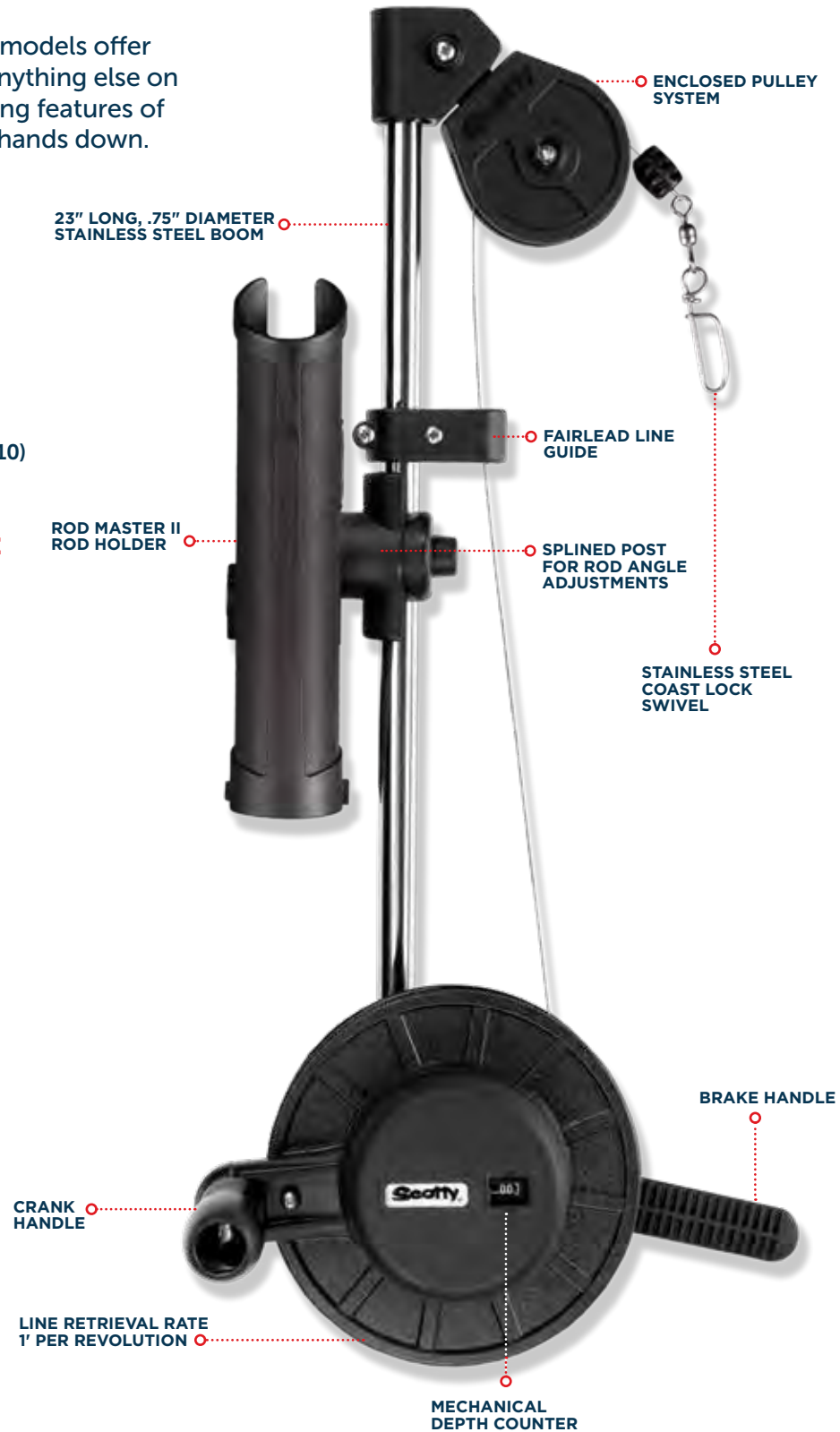

**1050
DEPTHMASTER**
The perfect introductory downrigger.
One foot per turn of the spool. 23" long .75"
diameter boom.

**1050MP
MASTERPACK**
The perfect clamp on downrigger.
23" long, .75" diameter boom. Includes 1021
portable anodized aluminum clamp mount.

**1060
DEPTHKING**
Ideal for the small boat that fishes deep and
needs a high speed retrieval. Includes a high
speed 2 ft. per turn of the spool. 23" long,
.75" diameter boom.



LAKETROLLER DOWNRIGGER

Laketroller Downriggers built for the smaller boat.
Great for aluminum boats, kayaks and canoes.

LAKETROLLER FEATURES

LINE RELEASE
Power Grip Plus 18" (1181)

DOWNRIGGER CABLE/LINE
200 ft. of 150 lb. test stainless
steel cable

FACTORY & FIELD TESTED

FULLY ASSEMBLED

WARRANTY
Limited Lifetime

1071 CLAMP MOUNT

Comes with fully portable engineering grade
modified nylon clamp for mounting on the
gunnel or transom (2" opening) Great for
aluminum boats and canoes. 1 ft. per
turn of the spool.

1073 SIDE DECK MOUNT

Permits mounting on a flat deck surface or on
the side of a gunnel or transom. The mounting
design gives 360° of rotation. Comes with a 241
Side Deck mount. 1 ft. per turn of the spool.

CRANK HANDLE

LINE RETRIEVAL RATE
1' PER REVOLUTION

STAINLESS STEEL
COAST LOCK SWIVEL

200FT, 150LB
STAINLESS STEEL
CABLE

BRAKE TENSION KNOB

12" LONG .3125"
DIAMETER STAINLESS
STEEL BOOM



DOWNRIGGER MOUNTS



1023 TILT-UP MOUNTING BRACKET

Extra mounting bracket for all Scotty tilt-up Downriggers. Also used as the mounting bracket for the Scotty 2500 Line Puller.
Dimensions: 2.5" x 4.5"
Bolting dimensions: 3.75" x 1.625"



1036 MOUNTING PLATE

Extra mounting plate for 1026 Swivel Mount and 2606/2612 Pedestal Risers.
Dimensions: 5.5" x 5.5"
Bolting dimensions: 4.5" x 3.5"



1026 SWIVEL MOUNT

Full 360° of rotation with 16 locking positions. Comes with 1036 Mounting Plate. Fits all Scotty Downriggers (except Laketrollers). Works with Scotty 1023 and 1010.
Dimensions: 5.5" x 5.5" x 4"
Bolting dimensions: 3.5" x 4.5"



1027 RAIL MOUNT

Fits up to 1.5" round rails, including oval-shaped wooden rails. Transfers the downward pressure to the boat gunnel. Fits all Scotty Downriggers (except Laketrollers) Works with Scotty 1023, 1026 and 1010.
Dimensions: 6.125" x 7.125"



1025 RIGHT ANGLE SIDE GUNNEL MOUNT

for boats with narrow or uneven gunnels. Fits all Scotty Downriggers (except Laketrollers) Works with Scotty 1023, 1026 and 1010.
Dimensions: 6" x 6" x 6" (top plate)
Bolting dimensions: 2" x 4" (side plate)



1037 MOUNTING PLATE

Extra mounting plate for 1025 Right Angle Side Gunnel Mount.
Bolting dimensions: 2" x 4" (side plate)



2650 DOWNRIGGER TRACK MOUNT

Fits all standard 3" gunnel tracks. Easily adjustable t-knobs securely hold mount in place. Corrosion resistant stainless steel track mount stands 4.75" tall. Works with Scotty 1026, 1023 and 1010.



1028/1029 GIMBAL MOUNT - 9" GIMBAL MOUNT - 12"

Made from welded stainless steel for strength and durability. For use in factory mounted gimbal rod holders only. Fits all Scotty Downriggers (except Laketrollers) Works with Scotty 1023, 1026 and 1010.
Dimensions: 1028 6.125" x 7.125" (top plate) 9" x 1.5" dia. (gimbal), 1029 6.125" x 7.125" (top plate) 12" x 1.75" dia. (gimbal)



2606/2612 PEDESTAL RISER - 6" PEDESTAL RISER - 12"

Made from 2" stainless steel tubing for the ultimate in strength and durability. Works with Scotty 1023, 1026 and 1010.
Plate Dimensions: 5.5" x 5.5"
Bolting Dimensions: 3.5" x 4.5"

DOWNRIGGER MOUNTS



1021 PORTABLE CLAMP-ON BRACKET

Portable mounting option. Great for aluminum boats. Double stainless steel bolts and black anodized aluminum. 2" clamp opening. To be used with 1010 Mounting Bracket (sold separately).
Dimensions: 5.625" x 4.75" x 3.125"



1010 QUICK-SLIDE DECK MOUNTING BRACKET

Works with the 1025 through 1029 optional mounts.
Dimensions: 4.75" x 5.625"
Bolting Dimensions: 2.625" x 4.875"



2027 STANCHION MOUNT

Enables you to quickly mount a downrigger to your boat's railing stanchion for extra stability. Fits all Scotty Downriggers (except Laketrollers) and can be used with 1026 Swivel Mount.
Dimensions: 6" x 6" x 6" (top plate)
Bolting Dimensions: 2" x 4" (side plate)

DOWNRIGGER DUAL ROD HOLDER MOUNTS



247 DUAL ROD HOLDER

For use with 1026 Swivel Mount.



447 DUAL ROCKET LAUNCHER ROD HOLDER

For use with 1026 Swivel Mount.



SCOTTY SEEKER™



The Scotty Seeker™ represents a radical advancement in Downrigger trolling technology providing anglers with a clear, straightforward method to monitor water conditions.

Temperature, depth and speed are constantly monitored by the Seeker probe and relayed anywhere on the boat via MFD, smartphone, or tablet. Refresh rates ranging from 5 to .5 seconds.

The Seeker system comes with everything you'll need to get started, including a hydrodynamic probe, hydrophone, a communication hub, and a rapid charging station that delivers over 100 hours of operation per cycle.

Developed by Airmar™ – the world leader in marine acoustics – and backed by Scotty's service and expertise, the Seeker offers cutting edge performance paired with legendary support and reliability.

Built For The Hunt™

DEPTH
True depth measurement at the probe

TEMPERATURE
Fast response temperature sensor

SPEED
High Performance paddle wheel delivers unmatched low speed accuracy

BATTERY
Fast wireless charging. Approximately 40 hour battery life

LOW DRAG
Hydrodynamic design to cut through water

PROBE MODES
Data refresh rate every 5 seconds on normal mode or every half second on thermocline mode

COMPATIBILITY
Compatible with IOS, Android and most MFDs

SEEKER APP
Easy to install and use

UNIQUE IDENTITIES
Assignable probe identifiers by numbers and locations on your boat

CONSTRUCTION
Designed, tested, manufactured and assembled by Scotty® and Airmar®

CONNECTIVITY
Bluetooth, wireless connectivity and ethernet

EXPANDABILITY
Accommodates up to 4 probes simultaneously

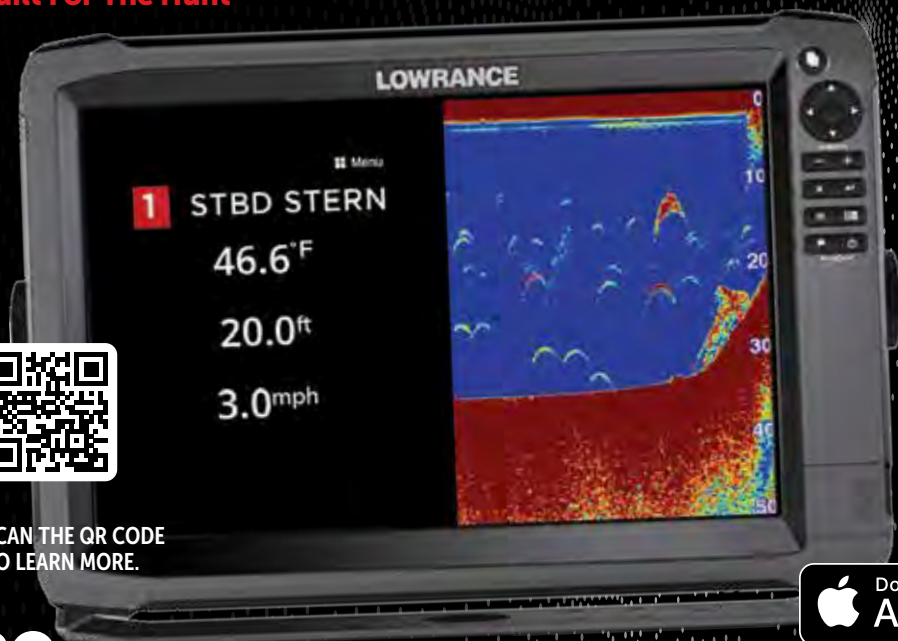

SCOTTY SEEKER SYSTEM OVERVIEW

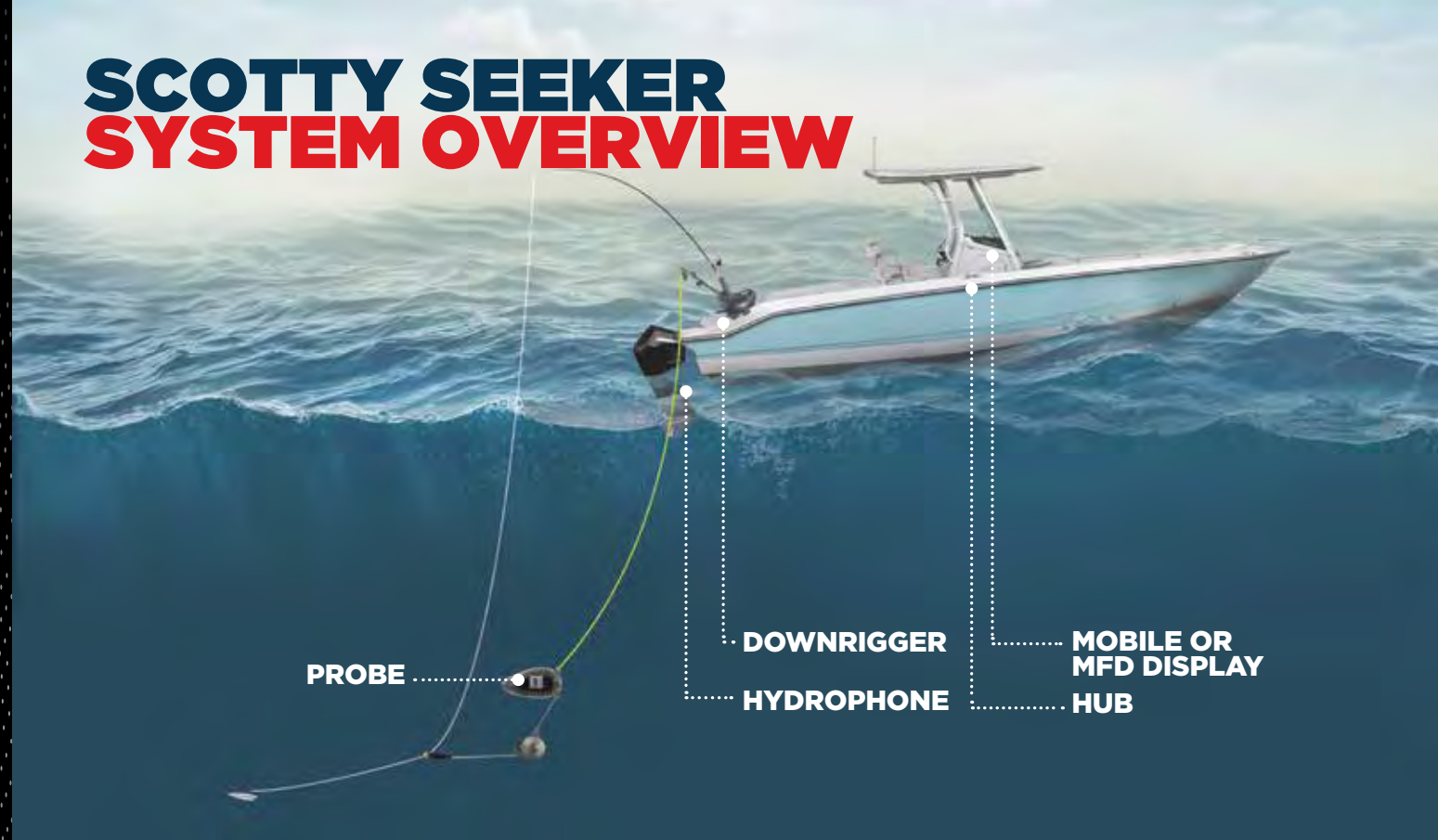

5000 SEEKER COMPLETE SYSTEM

The Scotty Seeker™ package includes one probe, one charging dock, one communication hub, one hydrophone, one power cord, one stainless steel leader and one major boost in fishing confidence.



SEEKER PROBE

Purpose built optimal performance to cut down drag through the water.



HYDROPHONE

Ultrasonic transducer technology. Designed by Airmar® and based on the popular P66 and TM165HW transducer.



COMMUNICATION HUB

Built-in wireless security between the hub and your mobile devices.



STAINLESS STEEL LEADER

A leader to separate your probe from your cannonball.



POWER CORD

6' - 12V marine grade power cable.



PROBE CHARGER

Designed to securely hold your probe in place while wireless charging.

DOWNRIGGER PARTS & ACCESSORIES

- A 1148**
Downrigger Weight Hook For 1.25" boom
- B 1147**
Downrigger Weight Hook For 1" boom
- C 1142**
Manual Downrigger Handle
- D 1139**
Downrigger Pulley Upgrade
- E 1158**
Depthpower Downrigger Spare Parts Kit
- E 1159**
High Performance Downrigger Spare Parts Kit
- F 1128**
Spare Drive Belts for 2 belt Depthpower Downriggers, 2000 models and earlier, dual belt model
- F 1129**
Spare Drive Belts for 1 belt Depthpower Downriggers, 2001 models and later
- F 2129**
Spare Drive Belts for High Performance Downriggers and Line Puller
- G 3134**
Downrigger Locking Plates for electric or manual downriggers (3 pcs)
- H 1132**
Emergency Crank Handle for Electric Downriggers

- I 1035**
1.75" Replacement Mounting Bolts (2 pcs)
- J 1135**
2.25" Replacement Mounting Bolts (2 pcs)
- K 3022**
Weight Mate (2 pcs)
- L 1014**
Downrigger Pulley Replacement Kit
- M 1034**
4.5" Downrigger Mounting Bolt (2000 models and earlier)
- N 1134**
6" Downrigger and Line Puller Mounting Bolt (2001 Downrigger models and later)



COUNTERS & ACCESSORIES



1146
MANUAL COUNTER
with Base



1145
DEPTHPOWER COUNTER
with Base



2134
HIGH PERFORMANCE DIGITAL COUNTER
(replaceable AAA Battery)



1024
MANUAL COUNTER COVER



1131
DEPTHPOWER REPLACEMENT LID



2133
HIGH PERFORMANCE REPLACEMENT LID
with Digital Counter

POWER ACCESSORIES

A 1124
FUSE HOLDER
30 amp marine in-line (fuse included)

B & C 1126
DOWNRIGGER SOCKET
Hella® 12V

B C & E 1125
DOWNRIGGER PLUG & SOCKET SET
Hella® 12V-Maximum 12 volt 18 amp applications (1126 & 1127)

D 1133
DOWNRIGGER POWER WIRE
Premium tinned copper 10 gauge 2 conductor (12 ft.)

E 1127
DOWNRIGGER PLUG
Hella® 12V

H 2128
RIGHT ANGLE RECEPTACLE MOUNT

For Marinc® Downrigger Receptacle
F 2127
DOWNRIGGER PLUG
Marinc® 12V

G 2126
RECEPTACLE
Marinc® 12V

G & F 2125
PLUG AND RECEPTACLE SET (2127 & 2126) Marinc® 12V



DOWNRIGGER TACKLE



1007
RELEASE CLIP LOCATORS (10 pcs)



1039
SOFT STOP BUMPERS
For snap hooks (4 pcs)



1009
INSULATING DOWNRIGGER
weight swivel hooks



1151
COASTLOCK SNAP
with Sampo® swivel—350 lb. Test



1157
STAINLESS STEEL THIMBLE SET (2 pcs)



1150
COASTLOCK SNAPS
225 lb. Test (2 pcs)



1008-24 BK
AUTO STOP BEADS
For stainless steel line (24 pcs)



2008
AUTO STOP BEADS
For braided line (6 pcs)



1011
DOUBLE LINE
connector sleeves (10 pcs)



1008-6
AUTO STOP BEADS
For stainless steel line (6 pcs)

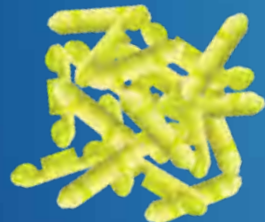

1008-24 YL
AUTO STOP BEADS
For stainless steel line (24 pcs)



1154
INSULATING TERMINAL KIT
with Snap Hook, Bumper & 3 Sleeves



1153
COASTLOCK SNAP
350 lb. Test



2404
AUTO STOP BEADS
180 lb. test(10 pcs)



1004
CONNECTOR SLEEVES
(10 pcs)

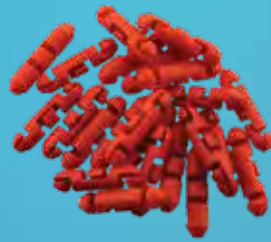

2008-24
AUTO STOP BEADS
For braided line (24 pcs)

DOWNRIGGER CABLE & LINE

PRODUCT # LENGTH LB TEST TERMINAL TACKLE

STAINLESS STEEL CABLE

STANDARD



1000	200 ft	150lb	NO
1001	300 ft	150lb	NO
1002	400 ft	150lb	NO
1000K	200 ft	150lb	YES
1001K	300 ft	150lb	YES
1002K	400 ft	150lb	YES

PREMIUM



2401K	300 ft	180lb	YES
2402K	400 ft	180lb	YES

BRAIDED LINE

HEAVY DUTY



2200K	200 ft	250lb	YES
2201K	300 ft	250lb	YES
2202K	400 ft	250lb	YES

PREMIUM



2700K	200 ft	200lb	YES
2701K	300 ft	200lb	YES
2702K	400 ft	200lb	YES

LOW DRAG



2800K	200 ft	150lb	YES
2801K	300 ft	150lb	YES
2802K	400 ft	150lb	YES

POWER GRIP PLUS LINE RELEASE



- 1.** Attach to your Downrigger Cable or Cannonball.
- 2.** Attach your fishing line to the Power Grip release by squeezing the jaws apart and placing your fishing line between the pads. The release tension is lighter at the outer tip, and is heavier the further into the jaws you place the line.
- 3.** The tension adjuster can be moved forward to decrease or back to increase the release tension.

POWER GRIP PLUS

- A 1170** 18" Monofilament Leader with Cannonball Snap
- B 1171** 18"
- B 1172** 30"
- B 1173** 48"
- B 1178** 60"
Monofilament Leader with Self Locating Snap

- C 1176** 6"
- C 1179** 30"
- C 1191** 48"
- C 1192** 60"
Stacker with Monofilament Leader and Cannonball Snap

- D 1177** Planer Board Snap
- E 1190** Power Grip Plus Pads (6 pcs)

MINI POWER GRIP PLUS

- H 1181** 18"
Wire leader with Cannonball Snap
- F 1180** 18"
- F 1183** 30"
Wire Leader with Self Locating Snap
- G 1182**
Planer Board Snap (4 pcs)



DOWNRIGGER SNUBBERS +

370
TROLLING SNUBBER
With ball bearing swivel and Self Locating Snap

371
TROLLING SNUBBER
With Self Locating Snap



3025
DOWNRIGGER WEIGHT RETRIEVER

1156
3" SELF LOCATING SNAP
Stainless steel (2 pcs)

1155
5" SELF LOCATING SNAP
Stainless steel (2 pcs)

374
SURE STOP
For 30 & 60" downrigger booms

1161
DUMMY FLASHER RIG
(2 pcs)

373
DIVER SNUBBER
(2 pcs)

375
SURE STOP PRO
For 30" boom

376 **SURE STOP PRO**
For 60" boom





377 **SURE STOP PRO**
For 30" boom with Snubber

378 **SURE STOP PRO**
For 60" boom with Snubber

LINE PULLER

High torque 12V motor pulls 1 crab trap or 4 prawn traps. 120 feet per minute retrieval speed. Accommodates .25" – .375" line. Compact size makes for easy stowing. Heavy duty stainless steel and composite construction. Easy access on/off switch. For recreational use only.

LINE PULLER FEATURES

-  **MOUNTS**
Non-tilting Mounting Bracket
-  **POWER SOURCE**
Marinco® 12V Plug & Receptacle (2125)
-  **POWER CORD**
Length 40"
-  **AMPERAGE POWER**
19 amp draw at 50 lbs.
-  **FACTORY & FIELD TESTED**
-  **FULLY ASSEMBLED**
-  **WARRANTY**
2 year



TRAP EASE

Crab and prawn trap roller for easy retrieval. Fits all Scotty post mounts.



749 TRAP-EASE
No mount.



750 TRAP-EASE
With 241 Side Deck Mount.



2515 LINE PULLER STOW AWAY BAG
This durable stow-away bag protects your Scotty Line Puller from the elements when not in use.

BAIT JARS

Vented lid for optimal scent release but prevents sea lice entry.

652
Fluorescent red .5 L bait jar

651
White 1 L bait jar

671
White 1 L vented bait jar

657
Fluorescent red 1 L bait jar

650
White .5 L bait jar

677
Fluorescent red 1 L vented bait jar

672
Fluorescent red .5 L vented bait jar

670
White .5 L vented bait jar

STRIKER ROD HOLDER

Designed and built tough for salmon, muskie, halibut, sturgeon, and other big game fish. Stainless steel reinforced post with an oversized opening and easy lock/unlock collar. The inner support rotates with the rod to instantly remove and strike simultaneously.



**239
STRIKER**
No mount.



**240
STRIKER**
With 241 Side Deck Mount.

LOCKING COLLAR



UNLOCKED

LOCKED

DESIGNED FOR BIG GAME FISH
LIKE HALIBUT, MUSKIE, SALMON,
STURGEON AND OTHER LARGE/
MEDIUM FISH SPECIES



SCOTT'S

ORCA ROD HOLDER

The inner sleeve opens in one smooth motion allowing your rod to be released in an instant. With one quick movement, your fishing rod is lifted straight out into the fish fighting position.

LARGE CRADLE DESIGN
FITS BIG REELS

UPWARD MOTION
OPENS ROD HOLDER

400
ORCA

With 241 L Locking Side Deck Mount.

TRANSPORT
LOCK TAB

7 LOCKING ANGLE
POSITIONS

401
ORCA

With 244L Locking Flush Deck Mount.

11 LOCKING
POSITION 360°
POST MOUNT

1.875" ID ACCOMMODATES
LARGE RODS



SMOOTH EASY OPEN ACTION

LOCKING TAB TO PREVENT ROD
LOSS WHILE TRAVELING

405
ORCA

With 459 Double Ended Extender.

ALL POST MOUNT SCOTTY
ROD HOLDERS ARE
FULLY ADJUSTABLE AND
INTERCHANGEABLE



POWERLOCK ROD HOLDER

Universal cradle holds almost any reel type. Fibre reinforced engineering grade nylon provides strength, resilience and reliability.



LOCKING COLLAR



256
POWERLOCK
Triple with 257 and 241 Mounts.



230
POWERLOCK
With 241 Side Deck Mount.
○○●



229
POWERLOCK
No mount.



231
POWERLOCK
With 244 Flush Deck Mount.



339
POWERLOCK
449 Clamp and 241 Mount
(maximum clamp opening 2").

ROD HOLDERS

Fibre reinforced engineering grade nylon offers strength, resilience and reliability. All post mount Scotty rod holders are fully adjustable up and down and with 360° of horizontal rotation. Models that include 241 side deck mount can be mounted on top or side of gunnel. Accommodates a wide range of rod and reel setups.



479
ROCKET LAUNCHER
No mount.



476
ROCKET LAUNCHER
With 241 Side Deck Mount.

ROCKET LAUNCHER INTERIOR DIAMETER: 1.7"



250
ROD MASTER
With 241 Side Deck Mount.



469
STAINLESS STEEL ROCKET LAUNCHER
No mount.



470
STAINLESS STEEL ROCKET LAUNCHER
With 241 Side Deck Mount.

STAINLESS STEEL ROCKET LAUNCHER INTERIOR DIAMETER: 1.7"



349
ROD MASTER II
No mount.



350
ROD MASTER II
With 241 Side Deck Mount.



351
ROD MASTER II
With 244 Flush Deck Mount.

ROD MASTER II INTERIOR DIAMETER: 1.85"



358
ROD MASTER II
Fits 1 .25" Scotty downrigger boom.



355
ROD MASTER II
Fits .75" and 1" Scotty downrigger booms.



222
SIDEWINDER
.3125" stainless steel construction.
237 Triggerlock Mount Included.
223 Sidewinder, No mount (not shown).

R-5 UNIVERSAL ROD HOLDER

The R-5 Rod Holder has been designed to securely hold your spinning, baitcaster, level wind, spincaster and fly rods with up to 15 lb test line. The adjustable .25" stainless steel lock bar pivots open to allow a quick effortless release of your rod. Fully adjustable lock bar tension adjusted with two number ten screws. Designed and backed by the Scotty name.

Scan the QR code to explore 290-R-5



BAITCASTER REEL

SPINNING REEL

SPINCASTER REEL

LEVEL WIND REEL

FLY REEL

289
R-5
No mount.

290
R-5
With 241 Side Deck Mount.



BAITCASTER SPINNING ROD HOLDER

Holds a Baitcaster reel securely in the cushioned cradle. A slot in the front of the rod holder allows for secure holding of a spinning reel. This rod holder is designed with a side mounted flange which leaves the bottom open. This allows for the rod holder to accommodate trigger grips. Rods can be secured with a soft latching strap which snaps over the top for Baitcaster or under the bottom for spinning reels.

CUSHIONED CRADLE
DESIGNED FOR BAITCASTERS
AND LEVEL WINDS

LATCHING
STRAP

SPINNING
REEL SLOT

1.25" OPENING ACCOMMODATES
SPINNING AND BAITCASTER RODS

11 LOCKING POSITION 360°
POST MOUNT

7 LOCKING
ANGLE
POSITIONS

284 BAITCASTER SPINNING

With 243 1.25" Square Rail Mount.

282 BAITCASTER SPINNING

With 438 Gear Head and 440-4 Track.

389 BAITCASTER SPINNING

With 449 Clamp and 241 Mounts. Maximum
clamp opening 2".

279 BAITCASTER SPINNING

No mount.

280 BAITCASTER SPINNING

With 241 Side Deck Mount.
○○●

281 BAITCASTER SPINNING

With 244 Flush Deck Mount.

388 BAITCASTER SPINNING

With 429 Gear Head Mount Extender
and 241 Mount.



FLY ROD ROD HOLDER

Innovative compact design allows for hands free trolling with a Fly Rod. Your rod can be secured in the rod holder with the soft latching strap which snaps over the top. Works well with short butt fly rods. All post mount Scotty rod holders are fully adjustable.



260
FLY ROD
No mount.



264
FLY ROD
With 244 Flush Deck Mount.



OPEN SIDE DESIGN HOLDS YOUR REEL IN PLACE

LATCHING STRAP

7 LOCKING ANGLE POSITIONS

11 LOCKING POSITION 360° POST MOUNT

1.125" OPENING ACCOMMODATES FLY RODS



267
FLY ROD
With 241 and 266 Float Tube Mounts.



265
FLY ROD
With 241 Side Deck Mount.





the way to fish[®]

ELECTRONICS MOUNTS

Mounting your fish finder has never been easier with our universal fish finder mount. Designed with a multi pattern top plate to fit most popular electronic brands. The perfect mount for your 7"-9" screens. The post mount allows you to install your screen in any of our Scotty post mount brackets. A full 360° of rotation allows you to position your screen in the perfect spot every time. Engineering grade nylon and stainless steel fasteners guarantee a lifetime of use even in the toughest conditions. Some assembly required. Accessories sold separately.

electronics mounts



367
UNIVERSAL SOUNDER FISH FINDER MOUNT

The perfect mount for your 7"-9" screens.



268
FLOAT TUBE FISH FINDER MOUNT

Adapt a fish finder to your float tube or pontoon boat. Includes transducer bracket and 6' strap.



368
UNIVERSAL SOUNDER FISH FINDER MOUNT

This uses a multi pattern universal top plate and the post mount design for quick removal and adjustable rotation.



272
SWIVEL FISH FINDER MOUNT

Mount only.



269
SWIVEL FISH FINDER MOUNT

With 241 Side Deck Mount.

ALL OF OUR PRODUCTS ARE MADE UNDER ONE ROOF TO DELIVER THE QUALITY YOU HAVE COME TO TRUST

TRANSDUCER MOUNTS

Made from high strength composite materials. Adjustable arms allow for multiple depths and angles. Collapses easily for storage. 415 Slip Discs for micro adjustments.

140 TRANSDUCER ARM

Transducer Arm telescopes from a compact 11.5 to 18" when fully extended. Includes 241L locking side deck mount and Scotty post (which fits into any Scotty rod holder mount).

141 TRANSDUCER ARM

Transducer Arm telescopes from a compact 11.5 to 18" when fully extended. Includes 438 gear head track adapter and our 440-4 low profile track.



BOTH TRANSDUCER MODELS HAVE SLIP DISCS THAT OFFER INFINITE MICRO POSITION CHANGES

BALL MOUNTS

1"

A system designed for full range of motion.



158 1" BALL TO TRACK

Adapt your Scotty low profile track to our 1" ball mounting system.



159 1" BALL TO POST

Adapt your Scotty post mount to our 1" ball mounting system.



150 1" BALL MOUNT

Universal mounting plate.



151 1" BALL MOUNT

Gear head & track.



152 1" BALL MOUNT

Gear head, post & side deck mount.

BALL MOUNTS

1.5"



162
1.5" BALL MOUNT
Gear head, post & side deck mount.



163
1.5" BALL MOUNT
Universal mounting plate for 7-9" Screens.



164
1.5" BALL MOUNT
Provides a mounting receptacle for 5-7" Screens.



168
1.5" BALL TO TRACK
Adapt your Scotty low profile track to our 1.5" ball mounting system.



169
1.5" BALL TO POST
Adapt your Scotty post mount to our 1.5" ball mounting system.



161
1.5" BALL 7" ARMS
Longer arm design for maximum positioning options.



166
1.5" BALL BASE
Compatible with 1.5" Scotty ball system.



165
1.5" BALL TOP PLATE
Designed for 7-9" screens.

2.25"



175
2.25" BALL TOP PLATE
Designed for 10-12" screens.



173
2.25" BALL MOUNT
Designed for 10-12" screens.



176
2.25" BALL BASE
241 hole pattern, allows pairing with: 449 Clamp Mount, 320 Rail Mount, 242 Rail Mount, 340 Track Adapter, 441 Backing Plate, 341 Glue On Pad, 2028 Gimbal Mount.



171
2.25" BALL 8" ARMS
Longer arm for maximum positioning options.



131 ACTION CAMERA BOOM

The Action Camera Boom offers a highly-flexible solution for mounting a GoPro or other action camera. Apart from the camera, our kit provides everything you need to start capturing great photos and videos. The 241 mount provides a solid foundation for two premium carbon fibre arms that can be pivoted to nearly any angle via a smooth central adjustment joint. The arms can also be separated, should your shot require a lower profile. The ball-joints allow 360° rotation on the pan axis and 180° of travel on the tilt axis, allowing you to capture the exact angle you want.



131



134 ACTION CAMERA MOUNT

Positioning your action camera at the perfect angle has never been easier. The integrated receiver is designed to be compatible with GoPro cameras. Just clip it on and start shooting. Dual ball-joints allows for 360° of rotation and 180° of tilt at both ends.

Easy grip knob allows big scene changes, or tighten them down to make ultra fine adjustments.

Our world-renowned engineering-grade nylon, complimented by stainless steel hardware, gives the 134 Action Camera Mount unmatched resistance to salt water and UV exposure. Includes post, track and rail mount-.875-1.25"



COMPATIBLE WITH GoPro AND OTHER ACTION CAMERAS

EASY GRIP T KNOB

DUAL BALL-JOINTS PROVIDE FLEXIBILITY FOR POSITIONING

159 POST MOUNT FITS ALL SCOTTY POST MOUNTING OPTIONS

MOUNTS INCLUDED



POST MOUNT



TRACK MOUNT



RAIL MOUNT .875-1.25"



139 PHONE HOLDER

Scotty's 139 Phone Holder offers a phone holder that is legitimately marine-grade. Varying temperatures, constant UV exposure and saltwater is no match for the engineering-grade materials that Scotty is famous for: strength, durability, and longevity. Our Phone Holder is made to withstand heavy use in harsh environments.

Positioning and securing your device has never been simpler or more reliable with an easy grip knob that allows for width adjustments. Secures devices between 2.75 and 3.75" wide. Another feature is the opening below for access to charge your device while in use. Includes post, track and rail mount-.875-1.25".

MOUNTS INCLUDED



STICK ON MOUNT



TRACK MOUNT



POST MOUNT



RAIL MOUNT

ENGINEERING-GRADE NYLON

STAINLESS STEEL HARDWARE

EASY GRIP T KNOB

KNOB ALLOWS FOR WIDTH ADJUSTMENTS SECURING DEVICES BETWEEN 2.75 AND 3.75" WIDE

DUAL BALL-JOINTS PROVIDE INFINITE FLEXIBILITY FOR POSITIONING

OPENING FOR ACCESS TO CHARGING DEVICE WHILE IN USE



149 TABLET HOLDER

Scotty's 149 Tablet Holder is made to withstand heavy use in harsh environments. Varying temperatures, constant UV exposure and saltwater are no match for the engineering-grade materials that Scotty is famous for: strength, durability, and longevity.

Positioning and securing your device has never been simpler and more reliable with an easy grip knob that allows for width adjustments securing devices between 5.75 and 9" wide. Position Tablet Holder in portrait position or landscape. Another feature is the opening below for access to charge your device while in use.

Easily adjustable for portrait and landscape positioning

Stainless steel fasteners

T-knob allows for width adjustments securing your devices between 5.75-9"

Large reinforced tabs securely hold devices in place

Engineering grade nylon

Large easy grip T-knob

1.5" Ball joints provide infinite flexibility for positioning

Opening for access to charging device while in use



POST MOUNTS



241 SIDE DECK MOUNT
Can be mounted on top or side of your gunnel.
○○●



241L LOCKING SIDE DECK MOUNT
A 241 mount with an easy to use lock and unlock push button system.



344 ROUND FLUSH DECK MOUNT
Sealed base for watertight applications.



243 SQUARE RAIL MOUNT
Fits 1.25" rail.



245 ROUND RAIL MOUNT
Fits 1.25" rail.



287 ROUND RAIL MOUNT
Fits .875" rail.



244 FLUSH DECK MOUNT
Sealed base for watertight applications.



244L LOCKING FLUSH DECK MOUNT
Locks and unlocks your post mount product easily by sliding a lever.



444 COMPACT THREADED DECK MOUNT
Use on gunnels up to 2" thick. Base cap for watertight applications.



248 OARLOCK MOUNT
Use the oarlock mount on your row boat to mount any Scotty post mount rod holder or accessory.



449 CLAMP MOUNT
Fully portable mounting option for all Scotty post mount rod holders and accessories, maximum clamp opening 2".



433 COAMING/GUNNEL CLAMP MOUNT
Position your rod holder or accessory virtually anywhere on the lip of your kayak's coaming or boat gunnel, maximum clamp opening 1.5".

ADAPTABLE RAIL MOUNT

Constructed from the same durable, rugged materials our brand is famous for and designed with versatility in mind, the 320 can be positioned almost anywhere along a 2" rail. Includes a pair of inserts for both 1.5" round rails, and the 1.25" square rails found on many pontoon boats. Corrosion-resistant fasteners are supplied. Also includes the 241 Side Deck Mount, which accommodates a vast range of Scotty rod holders and accessories.



SHOWN ON 2" RAIL

320 ADAPTABLE RAIL MOUNT
Accommodates square 1.25", round 2" & round 1.5" rail diameters.



INSERT FOR 1.25" SQUARE RAIL



INSERT FOR 1.5" ROUND RAIL



ADAPTERS



237 TRIGGERLOCK
Designed for 223 Sidewinder Rod Holder.



238 RAIL MOUNT ADAPTER
Works in conjunction with 237 Triggerlock Mount (.875" and 1" round rails).



441 BACKING PLATE
Adds structural support when attaching a side deck or Flush Deck Mount to a thin-walled watercraft.



242 RAIL MOUNT ADAPTER
Works with 241 Side Deck Mount (.875" and 1" round rails).



423 DOWNRIGGER ROD HOLDER ADAPTER
Convert your 1023 tilt-up mounting bracket into a rod holder mount. 241 Side Deck Mount required.



439 GEAR HEAD TRACK ADAPTER
Mount track accessories to your inflatable watercraft's pre-installed 341 mounts. Fasten track to 341 mount with supplied 1/4-20 x .5" stainless steel bolts. Slide and lock our 438 gear head Adapter or ball mount onto the track.

LOW PROFILE TRACK

Made from corrosion proof high strength composite materials that will last a lifetime. Use the 438 Gear Head Track Adapter to mount all of your favourite rod holders and accessories.



440-1 1" LOW PROFILE TRACK
Dimensions: 3.5" L x 1.75" W x .375" H
Bolting Dimensions: 1.75" x 1.125"

440-4 4" LOW PROFILE TRACK
Dimensions: 7" L x 1.75" W x .375" H
Bolting Dimensions: 1.75" x 1.125"

440-8 8" LOW PROFILE TRACK
Dimensions: 10.75" L x 1.75" W x .375" H
Bolting Dimensions: 1.75" x 1.125"



3" GUNNEL TRACK ACCESSORIES



340L 3" GUNNEL TRACK MOUNT
Combined with the 241L Side Deck Mount, is an optimal way to mount all Scotty post mount rod holders & accessories to your 3" gunnel track. Stainless steel fasteners included.



2650 DOWNRIGGER TRACK MOUNT
For standard 3" gunnel track. T-knobs hold mount in place. Corrosion resistant stainless steel. Stands 4.75" tall. Works with Scotty 1026, 1023 and 1010 Downrigger Mounts. Fits all Scotty downriggers (except Laketrollers).



333 TRACK MOUNTED ROD TREE
For standard 3" gunnel track. Equipped with 3 x Scotty Rod Master II adjustable rod holders. Ideal for use with planer boards. T-knob tightens down for optimal strength. Engineering grade nylon and stainless steel construction.

GEAR HEAD POST & TRACK ADAPTER MOUNTS

Quick and easy drop and lock system. Allows you to secure and reposition your rod holder or accessory with just a twist. Fits all Scotty post mount rod holders and accessories.



438 GEAR HEAD TRACK ADAPTER

Use the Track Adapter with the 440 Low Profile Track for quick and easy installation and removal of your favourite Scotty post mount product.



426 SIDE SLIDE TRACK ADAPTER

Our unique Track Adapter allows you to securely fasten your favourite post mount product to a side mounted track.



428 GEAR HEAD MOUNT

Use in conjunction with any of our height extenders to bring your rod or accessory closer to you.



LOCKING GUNNEL TRACK MOUNT

Scan the QR code to explore 343



343 LOCKING GUNNEL TRACK MOUNT

Purpose-built for boats with integrated gunnel tracks, the 343 securely attaches to your vessel without the need to drill holes or carry tools. Locks solidly in place, with a push-button release to remove. Compatible with all of your favourite post mount Scotty accessories.

T-BOLT FASTENERS INCLUDED

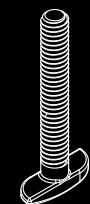

Compatible with Lund, Princecraft, Smoker Craft, Tracker and most other boats with internal gunnel track systems.

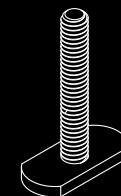

Compatible with Scotty Low Profile Track, and some boats with internal gunnel track.

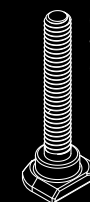

Compatible with Crestliner.

RECOMMEND USING ANTI-SEIZE ON BOLT THREADS



BOATING & FISHING ACCESSORIES



415



412



3010



311



990



210



414



125

311 CUP HOLDER, POST & BUTTON

Cup, post and gunnel mount.

310 CUP HOLDER & POST

Cup and gunnel mount.

415 SLIP DISKS

Allows you to make micro adjustments to your rod holder or any Scotty post mount products.

210 NET MINDER

A quick release and tangle free system for netting fish.

412 REPLACEMENT POST

The replacement post fits all Scotty post mount rod holders.

990 KNIFE SHARPENER

Safe and easy to use. Rotatable carbide blades included.

414 OFFSET GEARS

Doubles your rod holder positions for ultimate versatility.

3010 SNAP HOOK KEY CHAIN

Colours offered:



125 TUMBLER CUP

Holds up to 14 oz. Dishwasher safe.

BAIT BOARD & ACCESSORY TRAY



455 BAIT BOARD & ACCESSORY TRAY

Store all of your gear with the built in lure and accessory rack which gives you quick and easy access to everything you need. Keep knives, pliers and hook sharpeners in place between use for added safety.

TRIPLE MOUNTING SYSTEMS

Designed to be a multi-functional rod holder or accessory platform for any watercraft.



362 TRIPLE MOUNT

Fixed Mount.



257 TRIPLE MOUNT

With 241 Side Deck Mount.



452 GEAR CADDY

The 452 Gear Caddy provides anglers with a practical mobile base to keep tools and tackle organized, secure and readily available while on the water.

An integrated magnetic tray prevents hooks and lures from becoming scattered or lost, and built-in holders for cell phones, drinks and fishing rods keep those items right where they're needed.

With mounting options for tracks, bolts or posts, the Gear Caddy can be attached, re-positioned and removed from virtually any watercraft with ease.

MOUNTING OPTIONS



SIDE POST MOUNT



TRACK MOUNT



DECK POST MOUNT



MOBILE BASE TO KEEP
TOOLS AND TACKLE
ORGANIZED, SECURE AND
READILY AVAILABLE

EXTENSIONS & ADAPTERS

Extend and adapt all of your Scotty post or spline mount rod holders and accessories. Always have your fishing rod within reach and your favourite accessories at the perfect location.

259
HEIGHT
EXTENDER

8.25"

254
HEIGHT
EXTENDER

8"

254M
MINI
EXTENDER

4"

412
POST

1.75"

459
DOUBLE ENDED
EXTENDER

9.5"

253
GIMBAL MOUNT

1.5" diameter

9"

2028
GIMBAL MOUNT

1.5" diameter

11.25"

453
GIMBAL
ADAPTER

with gear head 1.5" diameter

10.5"

459M
MINI DOUBLE
ENDED EXTENDER

5.5"

429
GEAR HEAD
mount extender

11"

BOATING ACCESSORIES

101 OAR COLLARS

Made from polyethylene. Quick and easy to install. 1.75" inside diameter can be trimmed to fit smaller oars (fasteners included).



102 STRONGBACK OARLOCKS

2 .125" standard oar.



104 STRONGBACK OARLOCKS

1.75" small oar.



103 OARLOCK POSTS

Adapt your post mount to a .5" oarlock socket.



425 ROD BUTT CUSHION

The next best thing to a fighting belt. The Rod Butt displaces the pressure of your rod while playing fish.

327 FENDER RINGS

Use to attach a fender to your Scotty post mounts (2 pcs).

132 EXTRA LONG GRIP MOUNTING RIVETS

These structural rivets are an excellent solution for mounting hardware where you don't have access to the back side of a mount (10 pcs).

416 ROD BALANCER/REST

Non-resistance approach encourages more efficient and successful strike to hook-sets when fishing.

133 WELL NUT MOUNTING KIT

Securely fasten a multitude of products onto thin walled structures with ease. Available in 4 or 16 pack options (fasteners included).

590 SNAP HOOKS

Our nylon clips are a perfect solution for attaching items to your watercraft (6 pcs).

300BK TARP CLIPS

Quick and easy to use design with powerful locking jaws for the ultimate hold (4 pcs).



PADDLE SPORT



136 PADDLE CLIP
Permanently mount to your watercraft with 2 x #6 screws.



342 GLUE/STICK ON PADDLE CLIP
Easily clip your paddle to your inflatable watercraft with 1" x 6" PVC pad.



130 PADDLE LEASH
Secure your paddle or fishing rod.



276 ANCHOR LOCK
Anchor release system for small boats in still-water.



445 2" GLUE/STICK ON MOUNT
438 Gear Head.



436 STAND UP PADDLE BOARD LEASH PLUG ADAPTER
The Adapter attaches to your stand up paddle board's pre-installed leash plug with a stainless steel J-Hook. Accepts all post mount rod holders and accessories.

KAYAK STABILIZER

Easily inflatable bladders offer over 30 pounds of extra buoyancy and our unique assembly system makes installation and removal a breeze. The pontoons are made from a rugged PVC with thick outer shell for extra durability.

302 KAYAK STABILIZER
Over 30 lbs. of extra buoyancy. Our unique design makes installation and removal quick and easy.

STABILIZER ARM LENGTH: 28"
INFLATABLE PONTOON LENGTH: 30"
INFLATABLE PONTOON DIAMETER: 8"
ZIPPER OPENING: 30" LONG X 8" DIAMETER

Not recommended for surf launching or use in extreme conditions.

CONTAINS



REPLACEMENT POSTS (412) X2



BAITCASTER SPINNING ROD HOLDERS (279) X 2



LOCKING SIDE DECK MOUNTS (241L) X 4



INFLATABLE PONTOONS X 2



ANODIZED ALUMINUM STABILIZER ARMS (28") X2



ANCHOR LOCK & KIT



278 ANCHOR LOCK
Fixed Mount.



276 ANCHOR LOCK
241 Side Deck Mount.



277 ANCHOR LOCK
244 Flush Deck Mount.



797 ANCHOR KIT
Anchor Kit for still water use only.

KAYAK ACCESSORIES



UTILITY

- A 311** Cup Holder
- B 455** Bait Board & Accessory Tray
- C 452** Gear Caddy



A



B



C

TRACK

- D 440** 1" / 4" / 8" Low Profile Track
- E 343** Locking Gunnel Track Mount
- F 438** Gear Head Track Adapter



D



E



F

ROD HOLDERS

- G 290** R-5 Universal Rod Holder
- H 282** Baitcaster Spinning Rod Holder
- I 260** Fly Rod



G



H



I

ELECTRONICS MOUNTS

- J 141** Transducer Mount
- K 367** Universal Fish Finder Mount
- L 164** 1.5" Ball Mount with Sounder Plate



J



K



L

BALL MOUNTS

- M 151** 1" Ball Mount
- N 162** 1.5" Ball Mount
- O 163** 1.5" Ball Mount



N



M



O

SAFETY

- P 835** Sea Light
- Q 838** Sea Light
- R 793** Throw Bag
- S 276** Anchor Lock
- T 797** Anchor Kit



R



S



T



P



Q

KAYAK FISHING STARTER PACK

111 KAYAK FISHING STARTER PACK

Fishing essentials for outfitting your kayak. The Kayak Starter Pack includes: **A** 282 Baitcaster Spinning Rod Holder with Gear Head & Track **B** 136 Paddle Clip **C** 438 Gear Head Track Adapter **D** 311 Drink Holder **E** 455 Baitboard & Accessory Tray **F** 440-4 4" Low Profile Track.

Stainless steel fasteners included: #10 x.625. (Not intended for use with inflatable kayaks)



THE KAYAK FISHING STARTER PACK FROM SCOTTY COMES WITH ALL THE ESSENTIAL ACCESSORIES YOU'LL NEED TO OUTFIT YOUR KAYAK FOR FISHING

ACCESSORIES FOR INFLATABLES

416
ROD REST
241
SIDE DECK MOUNT
341
GLUE ON MOUNT

289
R-5 ROD HOLDER
241
SIDE DECK MOUNT
459
DOUBLE ENDED
EXTENDER

452
GEAR CADDY
241
SIDE DECK MOUNT
459M
MINI DOUBLE
ENDED EXTENDER

349
ROD MASTER II
1073
LAKETROLLER
250
ROD MASTER
257
TRIPLE MOUNT

779
SAFETY EQUIPMENT
KIT

793
RESCUE THROW BAG

276
ANCHOR LOCK
341
GLUE ON MOUNT

455
BAIT BOARD
429
GEAR HEAD
MOUNT EXTENDER
241
SIDE DECK MOUNT

161
1.5" BALL 7" ARMS
166
1.5" BALL BASE
241
SIDE DECK MOUNT

140
TRANSDUCER ARM
241
SIDE DECK MOUNT
341
GLUE ON MOUNT

MOUNTS GLUE/STICK ON

3M™ VHB™ Tapes utilizes modified acrylic adhesive on both sides of a very conformable, adhesive foam core.



341
GLUE ON MOUNT
Manufactured from flexible PVC and can be bonded to PVC or Hypalon inflatable boats. Includes stainless steel fasteners. Many different glue products will work for adhering the 341 mount to your water craft.
MOUNTING DIMENSIONS: 5"W X 7"H



342
GLUE/STICK ON PADDLE CLIP
Our super-strong Paddle and Landing Net Clip now comes with the option of a glue/stick-on mounting pad. Easily clip in and secure a paddle or Landing Net. Great for inflatable watercraft, where drilling holes is not an option. Includes 3M™ VHB™ Tape.



445
2" GLUE/STICK ON MOUNT
Position your Scotty Accessory virtually anywhere on your SUP, Kayak or boat surface with this non-permanent solution. Gear Head Mount makes it easy to drop and lock. Includes 3M™ VHB™ Tape. Using rod holders with this mount, is for storage purposes only.
STICK-ON BASE DIAMETER: 2"

SAFETY EQUIPMENT



835 SEA-LIGHT WITH SUCTION CUP MOUNT

Designed to meet the demands of the sea. Ideal for a small watercraft, within a vehicle, attached to life jackets, backpacks and for camping. Suction cup mounted, ACR detachable, fully sealed LED C-Light™, 20 Lumen White LED. Operating life over 30 hours. Twist ON/OFF activation. Impact resistant. USCG/SOLAS approved. Requires two "AA" 1.5V batteries (not included).

838 SEA-LIGHT WITH POLE & BALL MOUNT

Ball System joint design enables full range of motion. Corrosion proof construction provides a long service life in both fresh and salt water applications, designed with stainless steel pole and fasteners. ACR detachable, fully sealed LED C-Light™, 20 Lumen White LED. Operating life over 30 hours. Twist ON/OFF activation. Impact resistant construction and is USCG/SOLAS Approved. Requires two "AA" 1.5V batteries (not included).

BASE MOUNT DIMENSIONS: 2.25" X 2.25"
OVERALL HEIGHT: STANDS 41" TALL
SEA-LIGHT POLE DIAMETER: .5".
POST MOUNT INCLUDED.



130 PADDLE LEASH



779 SMALL VESSEL SAFETY EQUIPMENT



780 SAFETY WHISTLE

784 PEALESS SAFETY WHISTLE



793 RESCUE THROW BAG

HAND PUMPS

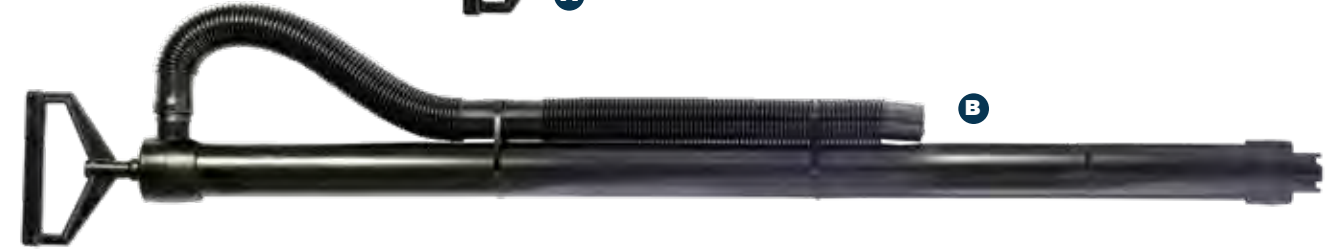

A 545K KAYAK PUMP
25.5" overall length.

D 544 HAND PUMP
18.5" overall length.

B 548 HAND PUMP
39" overall length.

E 545 HAND PUMP
25.5" overall length.

C 544K KAYAK PUMP
18.5" overall length.



JORDAN SCOTTY

FISH EGG INCUBATOR SYSTEMS

The Jordan/Scotty Fish Egg Incubator is a scientifically designed and tested plastic incubation unit and was developed to provide an efficient aid in the stream incubating of fish eggs. The unique design either eliminates or minimizes most of the problems experienced by natural spawning.



Scan the QR
code to explore
incubator video



WHERE TO OBTAIN EGGS

Contact your local Department of Fisheries & Oceans or similar agency. In Canada, contact the DFO Community Advisor. The disposition of salmonid eggs is carefully supervised in order to meet requirements.

WHERE TO OBTAIN JORDAN SCOTTY INCUBATOR SYSTEMS

These egg incubator units are available at a nominal price to cover minimum raw materials and labour costs.

Scotty Manufacturing Ltd.
1-800-214-0141
incubator@scotty.com

SCOTTY FISHING & OUTDOOR PRODUCTS

2065 Henry Ave West Sidney, British Columbia Canada V8L 5Z6

PHONE 250 656 8102
TOLL FREE 1 800 214 0141
FAX 250 656 8126
EMAIL scotty@scotty.com

www.scotty.com

PROUDLY MADE IN CANADA



Check in with Scotty's social media channels to learn about new products, promotions, give-aways, news and information.

To submit your photos send them to
social@scotty.com