



the  
way  
to  
fish<sup>®</sup>

# table of contents

## DOWNRIGGERS

- 6 what is a downrigger
- 7 choosing your downrigger
- 8 high performance
- 10 depthpower
- 12 manual
- 14 compact
- 16 laketrroller

## DOWNRIGGER MOUNTS

- 18 downrigger mounts
- 19 compact downrigger mounts
- 19 downrigger dual rod holder

## DOWNRIGGER PARTS & ACCESSORIES

- 20 parts & accessories
- 22 downrigger tackle
- 23 cable & line

## LINE RELEASES

- 26 power grip plus
- 26 mini power grip plus
- 27 snapper
- 27 mini snapper

## LINE PULLERS

- 28 electric
- 28 manual
- 29 bait jars

## ROD HOLDERS

- 30 R-5
- 32 orca
- 34 striker
- 36 power lock
- 40 rocket launcher
- 40 rodmaster II
- 41 rodmaster

- 41 side winder
- 42 baitcaster spinning
- 44 fly rod

## MOUNTS

- 46 electronic mounts
- 49 transducer mounts
- 50 ball mounts
- 54 locking gunnel track mount
- 56 post mounts
- 57 adaptors
- 57 triple mounting system
- 58 low profile track
- 58 gear head
- 65 glue/stick on mounts

## ACCESSORIES

- 60 inflatable accessories
- 62 track adaptor
- 64 fishing accessories
- 66 extensions & adaptors
- 68 bait board
- 69 anchor lock
- 70 boating accessories

## PADDLE SPORTS

- 72 paddle sport accessories
- 73 kayak stabilizer
- 74 kayak accessories
- 76 kayak fishing starter pack

## SAFETY EQUIPMENT

- 78 sea-light
- 79 pumps

## JORDAN-SCOTTY

- 80 fish egg incubator systems

## 82 SOCIAL MEDIA

## stay connected

f **FACEBOOK**  
@scottyfishingproducts

ig **INSTAGRAM**  
#scottyproducts

tw **TWITTER**  
@scottyproducts

yt **YOUTUBE**  
#scottyproducts

www.scotty.com  
www.scottypaddlesports.com  
www.scottyfire.com

## legend

 **Water Surface**  
Best suited for still water

 **Vessel Recommendation**  
Suited for paddle sports

 **No assembly required**

 **Factory and field tested**

 **Colour options**

 **QR Codes**  
Scan using your phone's camera for more information

# Scotty®

**SINCE 1952**



**SCOTTY: THE WAY TO FISH!**

In 1952, Blayney Scott and his wife Almeda Scott started a small company in Victoria, British Columbia that pioneered the use of plastics in the manufacturing of salmon fishing, lures and other marine products. From humble beginnings, Scotty Manufacturing Ltd. evolved to produce thousands of products under the Scotty trademark which are sold to the fishing, marine, outdoor and firefighting industries worldwide. The company is now situated near the YYJ Victoria International Airport in an 85,000 sq.ft. manufacturing plant built in 2000, and has recently expanded.

The Scotty trademark has become recognized to mean product excellence. The total commitment to quality, fair pricing and unmatched service means our customers everywhere can expect reliability and satisfaction from every product that carries the Scotty name. This commitment has taken us to where we are today and will hopefully serve us well for many years to come. All products are backed by years of manufacturing experience and the highest quality customer service. Excellent vendor support and a superior product have made Scotty a leader in the fishing industry.

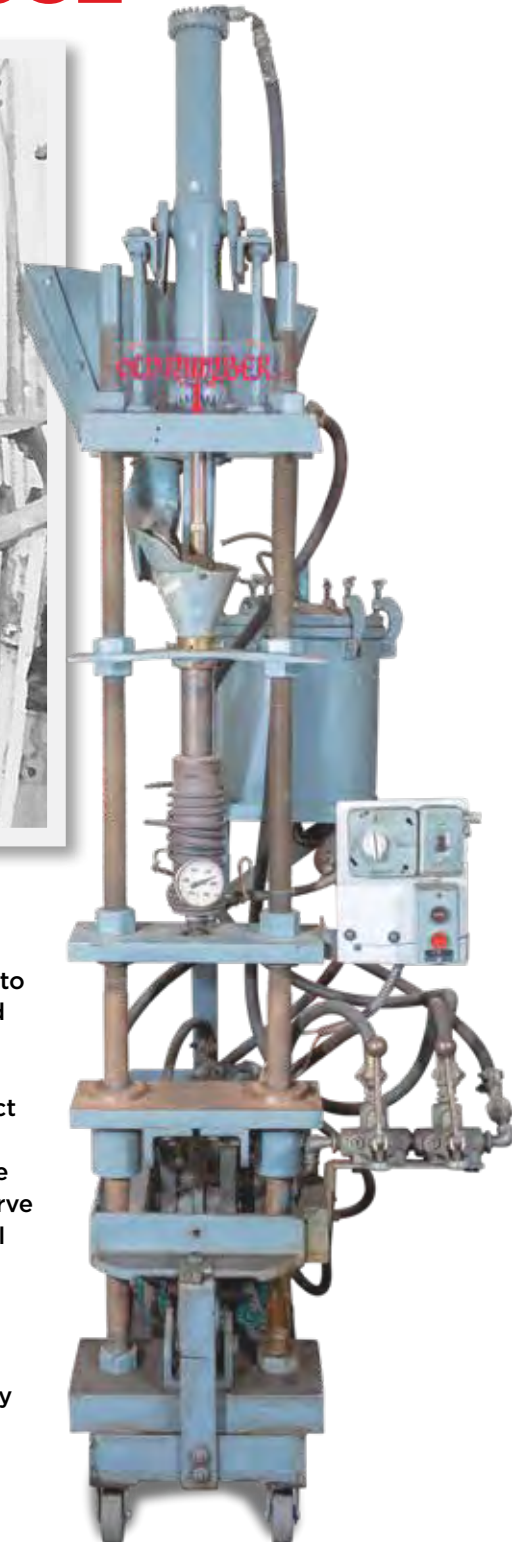

## SCOTTY | location



**Scotty Fishing & Outdoor Products**

2065 Henry Ave West  
Sidney, British Columbia  
Canada V8L 5Z6

**Phone:** 250 656 8102  
**Toll Free:** 1 800 214 0141  
**Fax:** 250 656 8126  
**Email:** [scotty@scotty.com](mailto:scotty@scotty.com)



**SCOTTY IS LOCATED ON VANCOUVER ISLAND, BRITISH COLUMBIA, CANADA**

# DOWNRIGGERS | explained

superior line release technology

Downriggers were created for one principal reason: to allow anglers to troll their lures at a specific depth.

Years of testing and practical use have shown that a moving bait or lure in the water, trolled at the depth where fish are present, is the best way to ensure a hookup and to get results.

Downriggers improved both trolling results, and the fun factor. They put the sport back in sport fishing.

The earliest Downriggers were very simple in form, generally consisting of a spool of wire mounted to the boat with a heavy weight hung on the end of the wire. The lure or bait was attached directly to the Downrigger weight and did not release when a fish struck.

The angler had to wind up both the weight and the fish. This concept of deep trolling became popular with sport fishermen when the idea of attaching a rod to the Downrigger, by means of a release clip, was introduced.

A release clip is attached to the wire and then the fishing line from the rod is clipped into the release. The Downrigger weight is then lowered to precisely the depth required.

When a fish hits, the line is released from the Downrigger wire, leaving the heavy weight on the Downrigger.

The angler is then free to fight the fish on the rod and reel alone, without the added drag of heavy lines and trolling weights used in the past. Scotty introduced its first Downrigger over 40 years ago and now produces the most complete range of Downriggers and accessories in the world.

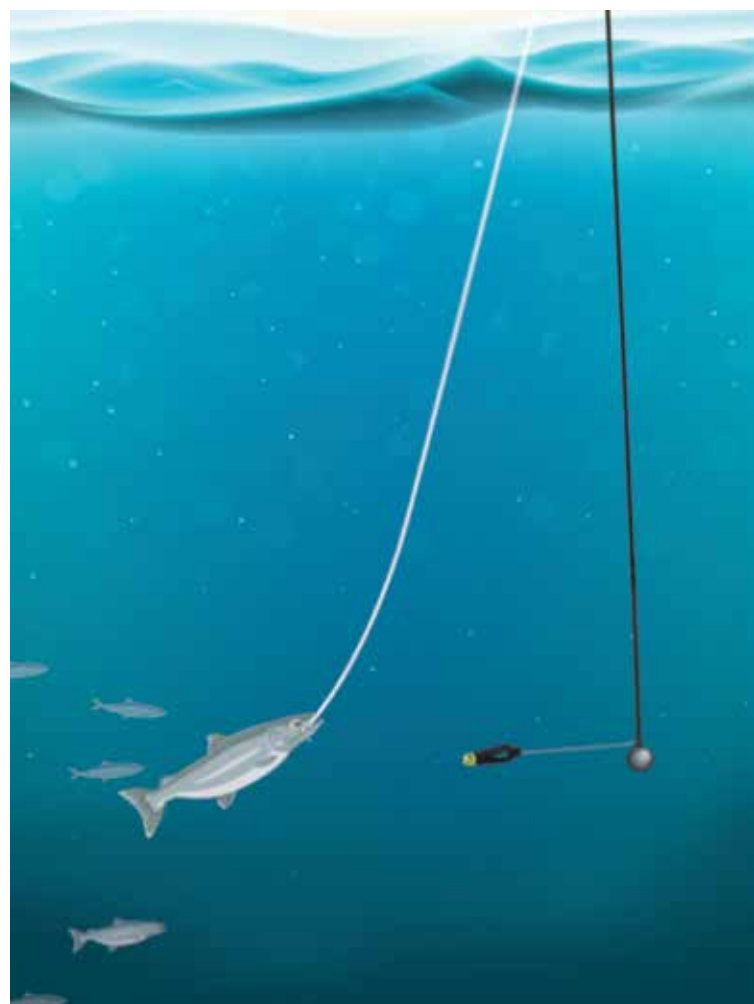
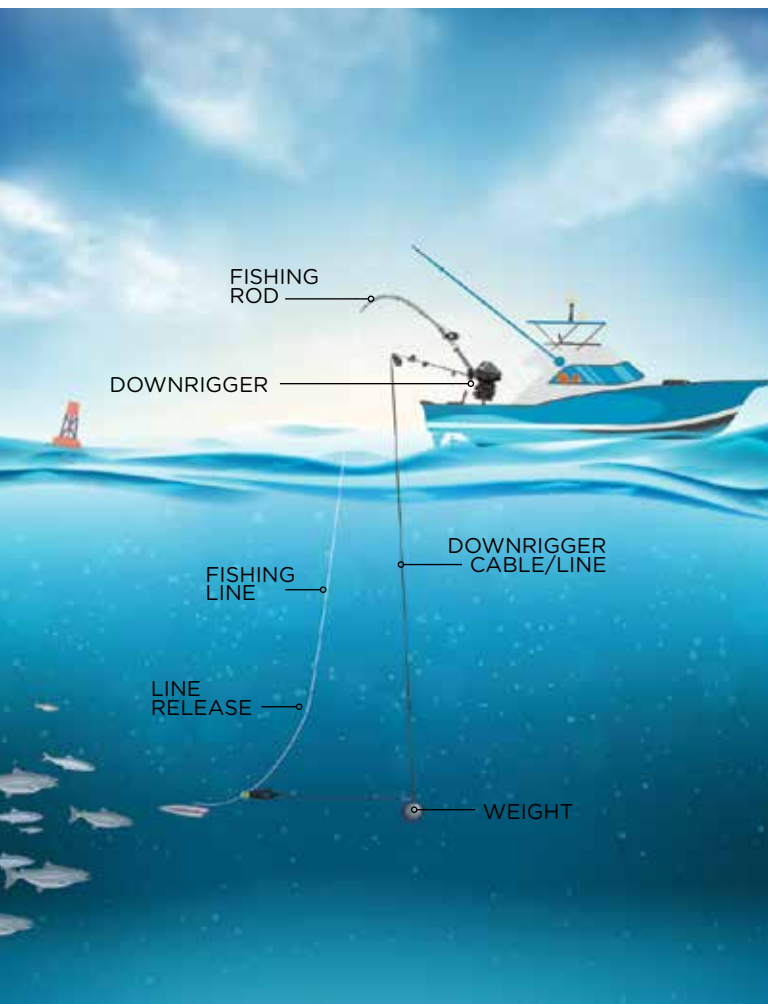

**1** Clip your fishing line to the Downrigger line using a Scotty Power Grip line release.

**2** Loosen the drag on your fishing reel and carefully let the Downrigger line out to a specific depth.

**3** When a fish strikes it pulls your fishing line out of the release and you are free to fight the fish on the rod and reel.

# CHOOSING | your downrigger

compare our models to find a perfect fit for you

## electric downriggers

All Electric Models have 12 v Marincor™ corrosion resistant plug + socket, locking tilt up mount, large surface automatic brake, spray protected positive-drive depth counter, Kevlar™ belt driven and an auto stop with jog button feature.

	HIGH PERFORMANCE			DEPTHPOWER				
STAINLESS STEEL CABLE	2106	2106B	2116	1099	1101	1106	1106B	1116
• premium test 150 lb.				250 ft.	250 ft.	250 ft.		250 ft.
• premium test 180 lb.	300 ft.		300 ft.					
BRAIDED LINE							300 ft.	
• premium test 200 lb.								
• premium test 250 lb.		300 ft.						
16 POSITION SWIVEL MOUNTING BASE	✓	✓	✓	SOLD SEPARATELY	✓	✓	✓	✓
POWER GRIP PLUS LINE RELEASE MODEL NUMBER	1170	1170	1170 & 1171	1170	1170	1170	1170	1170 & 1171
ROD HOLDER MODEL	358 RODMASTER II	358 RODMASTER II	447 DUAL ROCKET LAUNCHER	355 RODMASTER II	358 RODMASTER II	358 RODMASTER II	358 RODMASTER II	247 DUAL ROD HOLDER
WEIGHT STORAGE HOOK	✓	✓	✓	SOLD SEPARATELY	SOLD SEPARATELY	SOLD SEPARATELY	✓	✓
STAINLESS STEEL BOOM LENGTH	36" - 60" TELESCOPIC	36" - 60" TELESCOPIC	36" - 60" TELESCOPIC	24" FIXED	30" FIXED	36" - 60" TELESCOPIC	36" - 60" TELESCOPIC	36" - 60" TELESCOPIC
<b>HIGH PERFORMANCE</b>				<b>DEPTHPOWER</b>				
Weight	12lb.	15lb.	20lb.	7 lb.	10lb.	15lb.		
Retrieval Speed	304 ft./min.	295 ft./min.	260 ft./min.	235 ft./min.	222 ft./min.	203 ft./min.		
Amperage Draw	13 amps	14.5 amps	19.5 amps	4 amps	5 amps	8 amps		

LIMITED \*\*\*\*\*  
**LIFETIME WARRANTY**

## manual downriggers

	MANUAL			COMPACT			LAKETROLLER	
	1080 STRONGARM	1085 STRONGARM	1091 LONGARM COMBO PACK	1050 DEPTHMASTER	1050MP MASTERPACK	1060 DEPTHKING	1071 CLAMP MOUNT	1073 BRACKET MOUNT
PREMIUM 150 LB. TEST STAINLESS STEEL CABLE	200 ft.	200 ft.	200 ft.	200 ft.	200 ft.	200 ft.	100 ft.	100 ft.
LOCKING TILT-UP MOUNT	✓	✓	✓	N/A	N/A	N/A	N/A	N/A
POWER GRIP PLUS LINE RELEASE MODEL NUMBER	1170	1170	1170	1170	1170	1170	1181 MINI POWER GRIP PLUS	1181 MINI POWER GRIP PLUS
ROD HOLDER MODEL	355 RODMASTER II	358 RODMASTER II	358 RODMASTER II	355 RODMASTER II	355 RODMASTER II	355 RODMASTER II	N/A	N/A
WEIGHT STORAGE HOOK	SOLD SEPARATELY	SOLD SEPARATELY	SOLD SEPARATELY	N/A	N/A	N/A	N/A	N/A
STAINLESS STEEL BOOM - LENGTH	24" FIXED	30" FIXED	36" - 60" TELESCOPIC	23" FIXED	23" FIXED	23" FIXED	12" FIXED	12" FIXED
LARGE SURFACE AUTOMATIC BRAKE	✓	✓	✓	✓	✓	✓	MANUAL DRAG BRAKE	MANUAL DRAG BRAKE
SPRAY PROTECTED POSITIVE-DRIVE DEPTH COUNTER	✓	✓	✓	✓	✓	✓	N/A	N/A
SPOOL DIAMETER FT. PER TURN	2 ft.	2 ft.	2 ft.	1 ft.	1 ft.	2 ft.	1 ft.	1 ft.

# HIGH PERFORMANCE

## downrigger

highest performance and speed

Scotty High Performance Electric Downriggers have reached the highest performance and reliability standards yet, while remaining competitively priced. Thousands of anglers now enjoy the superior speed, power and years of reliability that only Scotty offers. Scotty's custom designed marine components and final quality control tests produce a Downrigger that is unmatched in the industry.

### FEATURES INCLUDED WITH HIGH PERFORMANCE MODELS

**Line Release**  
Power Grip Plus 18" (1170)

**Rod Holders**  
Rod Master II 2106 & 2106B models (358)  
Dual Rod Holders 2116 model (447)

**Mounts**  
Tilt-up Mounting Bracket (1023)

Swivel Mount (1026)

Right Angle Marincó Receptacle Mount (2128)

**Auto Stop** (1121)

**4 Auto Stop Beads**

**Weight Storage**  
Storage Hook (1148)

**Power Source**  
Marincó 12V Plug & Receptacle (2125)

Power cord length, 40"

**Downrigger Cable/Line**  
300 ft. of 180 lb. test stainless steel cable, 300 ft. of 250 lb. test braided line (2106B model)

**Counter**  
Digital Illuminated LCD (2134)

**Factory & Field Tested**

**Fully Assembled**

**Warranty**  
Limited Lifetime

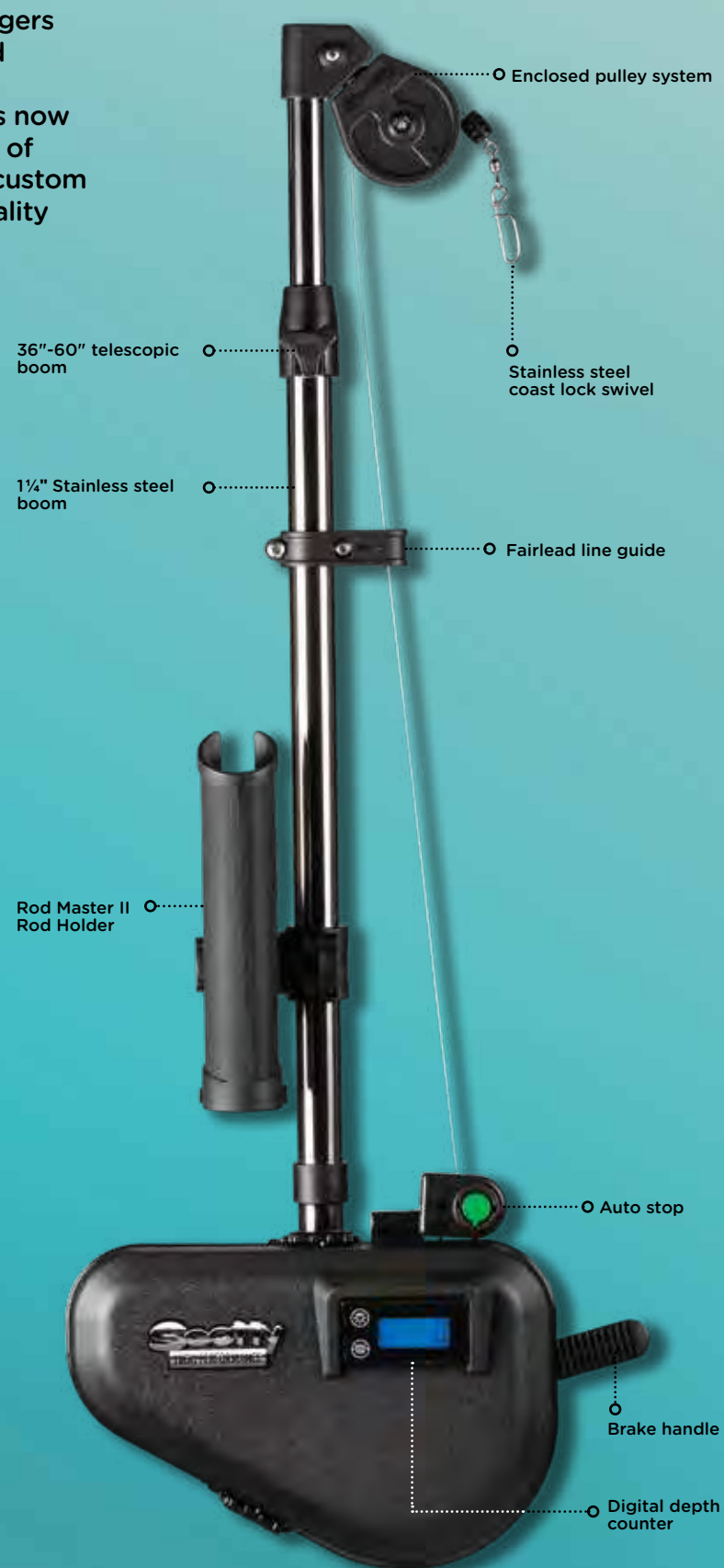

### 2106 | high performance

The Downrigger of choice for serious fishermen. Unmatched in power, performance and reliability. Equipped with 300 ft. of 180 lb. test stainless steel cable. 36"-60" long 1 1/4" telescopic boom.

### 2106B | high performance

Power and performance packaged with our strongest braided Downrigger line. Equipped with 300 ft. of 250 lb. test braided line. 36"-60" long 1 1/4" telescopic boom.

### 2116 | high performance propack

The number one choice in performance Downriggers for the charter captain. Equipped with 300 ft. of 180 lb. test stainless steel cable and our stainless steel rocket launcher dual rod holders. 36"-60" long 1 1/4" telescopic boom.



# DEPTHPOWER

# downrigger

superior speed, power and years of reliability

Scotty Depthpower Electric Downriggers have the highest performance and reliability standards ever, while remaining competitively priced. Thousands of fishermen now enjoy the superior speed, power and years of reliability that only Scotty offers. From custom designed marine motors to the final quality control tests, Scotty performance is unmatched in the industry.

## FEATURES INCLUDED WITH DEPTHPOWER MODELS

**Line Release**  
Power Grip Plus 18" (1170)

**Rod Holder**  
Rod Master II (358) 1101 model  
Rod Master II (355) 1099 model  
Dual Rod Holder (247) 1116 model

**Mounts**  
Tilt-up Mounting Bracket (1023)

Swivel Mount (1026)  
(except 1099 model)

Right Angle Marincó<sup>®</sup>  
Receptacle Mount (2128)

**Auto Stop (1121)**

**4 Auto Stop Beads**

**Weight Storage**  
Storage Hook (1148)  
(1106B & 1116 only)

**Power Source**  
Marincó<sup>®</sup> 12V Plug &  
Receptacle (2125)

Power cord length, 40"

**Downrigger Cable/Line**  
250 ft. of 150 lb. test stainless  
steel cable. 300 ft. of 200 lb. test  
braided line (1106B model only)

**Counter**  
Mechanical (1145)

**Factory & Field Tested**

**Fully Assembled**

**Warranty**  
Limited Lifetime

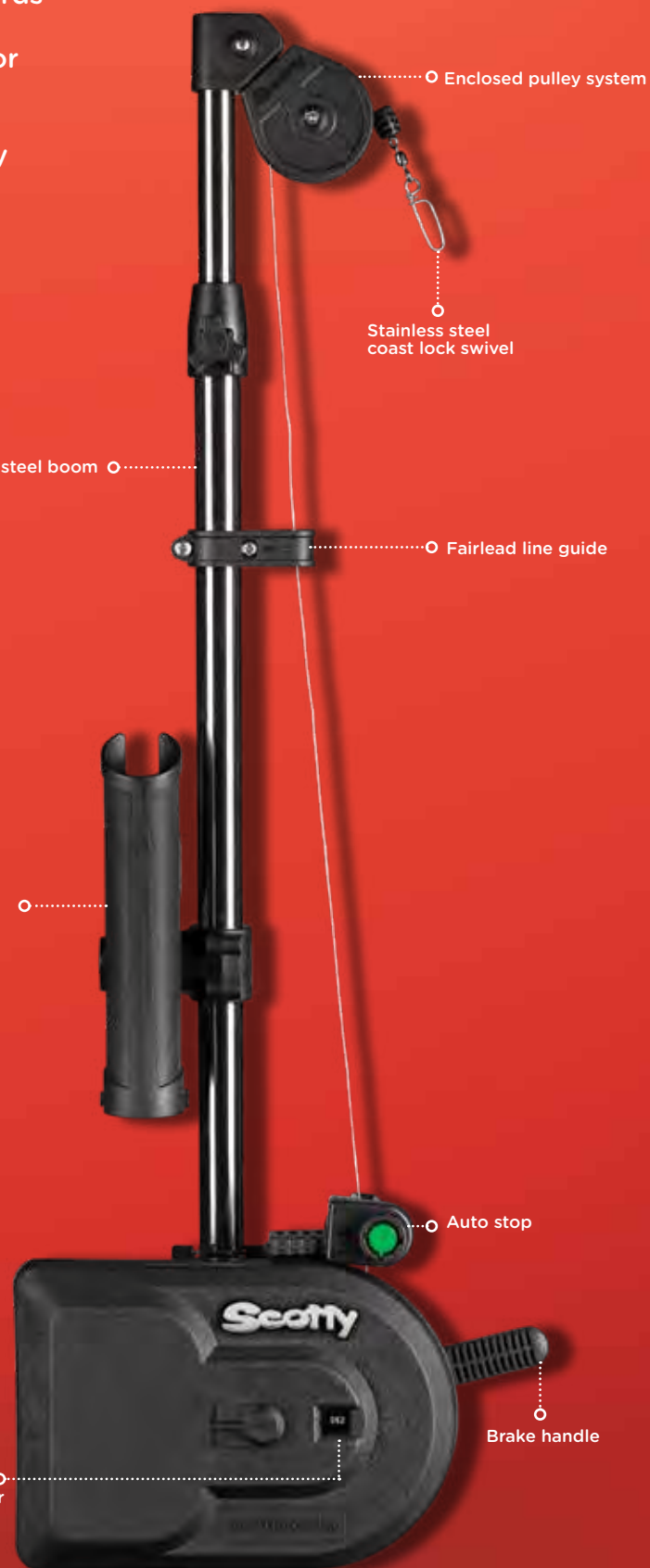

## 1099 | compact

All the performance features in an easy to stow compact size. Equipped with 250 ft. of 150 lb. test stainless steel cable. 24" long 1" diameter boom.



## 1101 | depthpower

Designed for heavy duty use, this unit will handle long hours and heavy weights in tough conditions. Equipped with 250 ft. of 150 lb. test stainless steel cable. 30" long 1 1/4" diameter boom.



## 1106 | depthpower

Our most popular electric Downrigger. Equipped with 250 ft. of 150 lb. test stainless steel cable. 36"-60" long 1 1/4" diameter telescopic boom.



## 1106B | depthpower

All the features you have come to love with our depthpower series. Now available with more options than ever. Equipped with 300 ft. of 200 lb. test braided line. 36"-60" long 1 1/4" diameter telescopic boom.



## 1116 | propack

The top choice of charter captains. Equipped with 250 ft. of 150 lb. test stainless steel cable. 36"-60" long 1 1/4" diameter telescopic boom.



## 3015 | downrigger cover

Protect your downrigger from the elements with our downrigger protective cover.











# MANUAL | downrigger

highest performance and reliability

Scotty Manual Downriggers have been the preferred choice of anglers for over forty years. They are engineered with a number of exclusive features contained in no other Downrigger.

## FEATURES INCLUDED WITH MANUAL MODELS

-  **Line Release**  
Power Grip Plus 18" (1170)
-  **Rod Holder**  
Rod Master II (358)
-  **Mounts**  
Tilt-up Mounting Bracket (1023)
-  **Downrigger Cable/Line**  
200 ft. of 150 lb. test stainless steel cable
-  **Counter**  
Mechanical (1146)
-  **Factory & Field Tested**
-  **Fully Assembled**
-  **Warranty**  
Limited Lifetime



### 1080 | strongarm

This Downrigger has outstanding features for small and intermediate size boats. Equipped with 200 ft. of 150 lb. test stainless steel cable. 24" long 1" diameter boom.

### 1085 | strongarm

The heavy duty workhorse of the Scotty manual lineup. Excellent for the intermediate size boat. Equipped with 200 ft. of 150 lb. test stainless steel cable. 30" long 1 1/4" diameter boom.

### 1091 | longarm

Ideal for big boats. Equipped with 200 ft. of 150 lb. test stainless steel cable. 36-60" long 1 1/4" diameter telescopic boom. Includes 1026 Swivel Mount.



# COMPACT downrigger

more value than anything else on the market

The Depthmaster and Depthking models offer more value for the anglers than anything else on the market. The price and operating features of these units beat the competition hands down.

## FEATURES INCLUDED WITH COMPACT MODELS

 **Line Release**  
Power Grip Plus 18" (1170)

23" Long, 3/4" diameter  
Stainless steel boom

 **Rod Holder**  
Rod Master II (355)

 **Mounts**  
Quick Slide Deck Mount (1010)

 **Downrigger Cable/Line**  
200 ft. of 150 lb. test  
stainless steel cable

 **Counter**  
Mechanical (1146)

 **Factory & Field Tested**

 **Fully Assembled**

 **Warranty**  
Limited Lifetime



## 1050 | depthmaster

The perfect introductory Downrigger. One foot per turn of the spool. 23" long, 3/4" diameter boom.

## 1050MP | masterpack 1060 | depthking

The perfect clamp on Downrigger. 23" long, 3/4" diameter boom. Includes 1021 portable anodized aluminum clamp mount.

Ideal for the small boat that fishes deep and needs a high speed retrieval. Includes a high speed 2 ft. per turn of the spool. 23" long, 3/4" diameter boom.









# LAKETROLLER | downrigger

light weight compact and easy to use

Laketroller Downriggers built for the smaller boat. Great for aluminum boats, kayaks and canoes.

## FEATURES INCLUDED WITH LAKETROLLER

-  **Line Release**  
Mini Power Grip Plus 18" (1181)
-  **Downrigger Cable/Line**  
100 ft. of 150 lb. test stainless steel cable
-  **Factory & Field Tested**
-  **Fully Assembled**
-  **Warranty**  
Limited Lifetime

### 1071 | clamp mount

Comes with fully portable engineering grade modified nylon clamp for mounting on the gunnel or transom (2" opening) Great for aluminum boats and canoes. 1 ft. per turn of the spool.



### 1073 | bracket mount

Mounting bracket permits mounting on a flat deck surface or on the side of a gunnel or transom. The mounting design gives 360° of rotation. Comes with a 241 Side Deck mount. 1 ft. per turn of the spool.

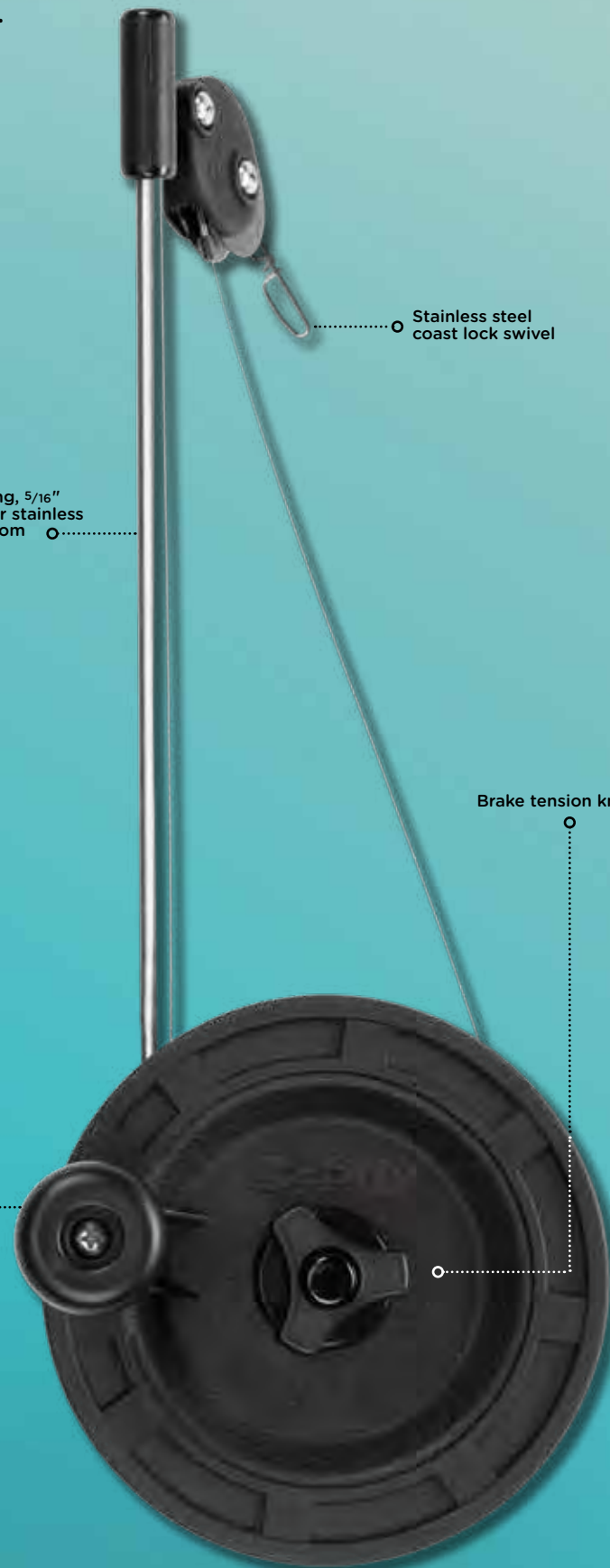

Stainless steel coast lock swivel

12½" long, 5/16" diameter stainless steel boom

Brake tension knob

Crank handle  
1' per revolution



# DOWNRIGGER | mounts



**1023 TILT-UP MOUNTING BRACKET**  
Extra mounting bracket for all Scotty tilt-up Downriggers. Also used as the mounting bracket for the Scotty 2500 Line Puller.  
**Dimensions:** 2 1/2" x 4 1/2"  
**Bolting dimensions:** 3 3/4" x 1 5/8"



**1036 MOUNTING PLATE**  
Extra mounting plate for 1026 Swivel Mount and 2606/2612 Pedestal Risers.  
**Dimensions:** 5 1/2" x 5 1/2"  
**Bolting dimensions:** 4 1/2" x 3 1/2"



**1026 SWIVEL MOUNT**  
Gives a full 360° of rotation with 16 locking positions. Comes with 1036 Mounting Plate.  
Fits all Scotty Downriggers (except Laketrollers).  
**Dimensions:** 5 1/2" x 5 1/2" x 4"  
**Bolting dimensions:** 3 1/2" x 4 1/2"



**1027 RAIL MOUNT**  
Fits up to 1 1/2" round rails, including oval-shaped wooden rails. Transfers the downward pressure to the boat gunnel. Fits all Scotty Downriggers (except Laketrollers) and can be used with 1026 Swivel Mount.  
**Dimensions:** 6 1/8" x 7 1/8"



**1025 RIGHT ANGLE SIDE GUNNEL MOUNT**  
For boats with narrow or uneven gunnels. Fits all Scotty Downriggers (except Laketrollers) and can be used with 1026 Swivel Mount.  
**Dimensions:** 6" x 6" x 6" (top plate)  
**Bolting dimensions:** 2" x 4" (side plate)



**1037 MOUNTING PLATE**  
Extra mounting plate for 1025 Right Angle Side Gunnel Mount.  
**Bolting dimensions:** 2" x 4" (side plate)



**2027 STANCHION MOUNT**  
The Scotty Stanchion Mount enables you to quickly mount a Downrigger to your boat's railing stanchion for extra stability. Fits all Scotty Downriggers (except Laketrollers) and can be used with 1026 Swivel Mount.  
**Dimensions:** 6" x 6" x 6" (top plate)  
**Bolting Dimensions:** 2" x 4" (side plate)



**1028/1029 GIMBAL MOUNT - 9"**  
**GIMBAL MOUNT - 12"**  
Made from welded stainless steel for strength and durability. For use in factory mounted gimbal rod holders only. Fits all Scotty Downriggers (except Laketrollers) and can be used with 1026 Swivel Mount.  
**Dimensions:** 1028 6 1/8" x 7 1/8" (top plate) 9" x 1 1/2" dia. (gimbal)  
1029 6 1/8" x 7 1/8" (top plate) 12" x 1 3/4" dia. (gimbal)



**2606/2612 PEDESTAL RISER - 6"**  
**PEDESTAL RISER - 12"**  
Made from 2" stainless steel tubing for the ultimate in strength and durability. Designed to be used with 1026 Swivel Mount, 1023 tilt-up Downrigger mount and 1010 compact Downrigger mount.  
**Plate Dimensions:** 5 1/2" x 5 1/2"  
**Bolting Dimensions:** 3 1/2" x 4 1/2"

# DOWNRIGGER | compact mounts



**1021 PORTABLE CLAMP-ON BRACKET**  
Portable mounting option. Great for aluminum boats. Double stainless steel bolts and black anodized aluminum. 2" clamp opening. To be used with 1010 mounting bracket (sold separately).  
**Dimensions:** 5 5/8" x 4 3/4" x 3 1/8"



**1010 QUICK-SLIDE DECK MOUNTING BRACKET**  
Works with the 1025 through 1029 optional mounts.  
**Dimensions:** 4 3/4" x 5 5/8"  
**Bolting Dimensions:** 2 5/8" x 4 7/8"

# DOWNRIGGER | dual rod holder



**247 DUAL ROD HOLDER**  
For use with the 1026 Swivel Mount.



**447 DUAL ROCKET LAUNCHER ROD HOLDER**  
For use with 1026 Swivel Mount.



# DOWNRIGGER | parts & accessories



**1132**  
EMERGENCY CRANK HANDLE  
(For Electric Downriggers)



**1147**  
DOWNRIGGER WEIGHT HOOK  
For 1" boom  
**1148**  
DOWNRIGGER WEIGHT HOOK  
For 1 1/4" boom



**1014**  
DOWNRIGGER PULLEY  
REPLACEMENT KIT



SPARE DRIVE BELTS  
**1128**  
For 2 belt Depthpower Downriggers,  
2000 models and earlier, dual belt model  
**1129**  
For 1 belt Depthpower Downriggers,  
2001 models and later  
**2129**  
For High Performance Downriggers  
and Line Puller (2500)

**1035**  
1 3/4" REPLACEMENT  
MOUNTING BOLTS (2 pcs)

**1135**  
2 1/4" REPLACEMENT  
MOUNTING BOLTS (2 pcs)

**1034**  
4 1/2" DOWNRIGGER MOUNTING  
BOLT (2000 models and earlier)

**1134**  
6" DOWNRIGGER/LINE PULLER  
MOUNTING BOLT (2001 Downrigger  
models and later)



**1139**  
DOWNRIGGER PULLEY UPGRADE



**1017**  
DOWNRIGGER LEAD WEIGHT  
3 lb. finned



**1158**  
DEPTHPOWER DOWNRIGGER  
SPARE PARTS KIT  
**1159**  
HIGH PERFORMANCE DOWNRIGGER  
SPARE PARTS KIT



**1142**  
MANUAL DOWNRIGGER HANDLE



**3134**  
DOWNRIGGER LOCKING PLATES  
For electric or manual downriggers (3 pcs)  
(locks sold separately)



**3022**  
WEIGHT MATE Holds your Downrigger  
weights securely (2 pcs)



**1146**  
MANUAL COUNTER WITH BASE



**1145**  
DEPTHPOWER COUNTER  
WITH BASE



**2134**  
HIGH PERFORMANCE DIGITAL  
COUNTER (replaceable AAA Battery)



**1024**  
MANUAL COUNTER COVER



**1131**  
DEPTHPOWER REPLACEMENT LID



**2133**  
HIGH PERFORMANCE REPLACEMENT  
LID WITH DIGITAL COUNTER

## POWER | accessories



**1125**  
HELLA® 12V DOWNRIGGER PLUG &  
SOCKET SET Maximum 12 volt 18 amp  
applications (1126 & 1127)

**1126**  
HELLA® 12V DOWNRIGGER SOCKET  
**1127**  
HELLA® 12V DOWNRIGGER PLUG



**1133**  
PREMIUM TINNED COPPER 12 GAUGE  
2 CONDUCTOR POWER WIRE (12 ft.)



**1124**  
30 AMP MARINE IN-LINE  
FUSE HOLDER (Fuse included)



**2127**  
MARINCO® 12V DOWNRIGGER PLUG



**2126**  
MARINCO® 12V DOWNRIGGER  
RECEPTACLE  
**2125**  
MARINCO® 12V DOWNRIGGER PLUG  
AND RECEPTACLE SET (2127 & 2126)

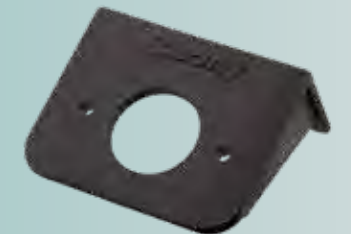

**2128**  
RIGHT ANGLE RECEPTACLE MOUNT  
For Marincos® Downrigger Receptacle

# DOWNRIGGER tackle



**1157**  
STAINLESS  
STEEL  
THIMBLE  
SET (2 pcs)

**1007**  
RELEASE CLIP  
LOCATORS  
(10 pcs)

**1150**  
225 LB.  
TEST  
COASTLOCK  
SNAPS  
(2 pcs)

**2008** (6 pcs)  
**2008-24** (24 pcs)  
AUTO STOP  
BEADS  
For braided line.

**1011**  
DOUBLE LINE  
CONNECTOR  
SLEEVES  
(10 pcs)

**1039**  
SOFT STOP  
BUMPERS  
For snap hooks  
(4 pcs)

**1008** (6 pcs)  
**1008-24** (24 pcs)  
AUTO STOP  
BEADS  
For stainless steel line.

**1004**  
CONNECTOR  
SLEEVES  
(10 pcs)

**1151**  
350 LB. TEST COASTLOCK SNAP  
WITH SAMPO® SWIVEL

**1152**  
350 LB. TEST LARGE  
COASTLOCK SNAPS

**1153**  
350 LB. TEST COASTLOCK SNAP  
TERMINAL TACKLE

**1154**  
INSULATING DOWNRIGGER  
WEIGHT SWIVEL HOOK WITH  
TERMINAL TACKLE

**1009**  
INSULATING DOWNRIGGER  
WEIGHT SWIVEL HOOKS

# DOWNRIGGER cable & line

**1000** stainless  
steel cable  
150 lb test

**1000**  
200 ft.

**1001**  
300 ft.

**1002**  
400 ft.

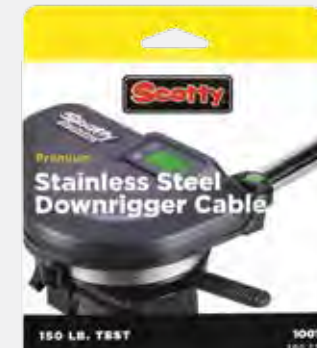

**2200** heavy duty  
braided line  
250 lb test

**2200K**  
200 ft. with  
terminal tackle

**2201K**  
300 ft. with  
terminal tackle

**2202K**  
400 ft. with  
terminal tackle

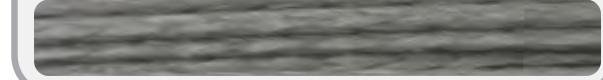
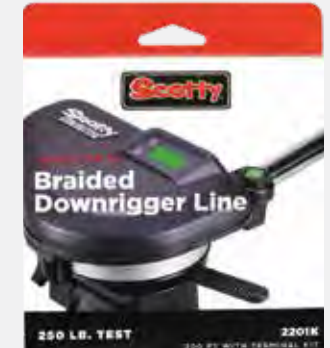

**1000K** stainless  
steel cable  
150 lb test

**1000K**  
200 ft. with  
terminal tackle

**1001K**  
300 ft. with  
terminal tackle

**1002K**  
400 ft. with  
terminal tackle

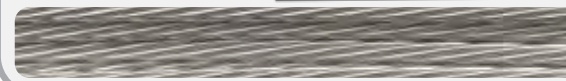
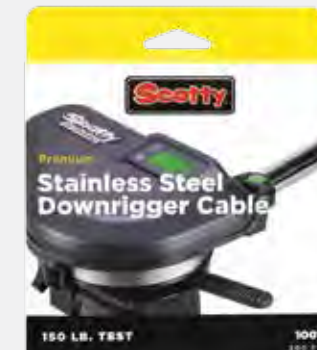

**2700** premium  
braided line  
200 lb test

**2700K**  
200 ft. with  
terminal tackle

**2701K**  
300 ft. with  
terminal tackle

**2702K**  
400 ft. with  
terminal tackle



**2400** hp stainless  
steel cable  
180 lb test

**2401K**  
300 ft. with  
terminal tackle

**2402K**  
400 ft. with  
terminal tackle

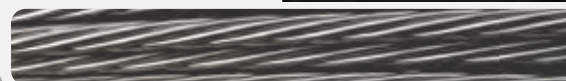

**2800** low drag  
braided line  
150 lb test

**2800K**  
200 ft. with  
terminal tackle

**2801K**  
300 ft. with  
terminal tackle

**2802K**  
400 ft. with  
terminal tackle

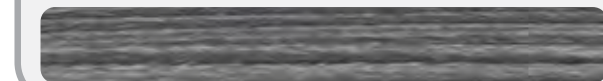
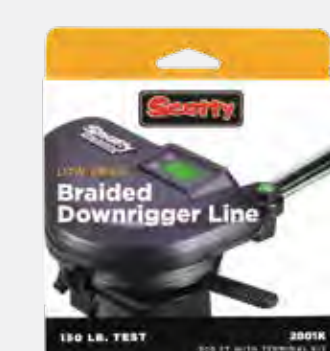

# DOWNRIGGER | snubbers & more



3025

371

370

1156/1155

374

1161

373

375/376

377/378

- 3025 DOWNRIGGER WEIGHT RETRIEVER**
- 370 TROLLING SNUBBER**  
with Ball bearing swivel and Self Locating Snap
- 371 TROLLING SNUBBER**  
with Self Locating Snap
- 1156 3" SELF LOCATING SNAP**  
Stainless steel (2 pcs)
- 1155 5" SELF LOCATING SNAP**  
Stainless steel (2 pcs)
- 374 SURE STOP ELECTRIC DOWNRIGGER STOPPER SYSTEM**  
For 30 & 60" Downrigger booms
- 1161 DUMMY FLASHER RIG** (2 pcs)
- 373 DIVER SNUBBER** (2 pcs)
- 375 SURE STOP PRO** for 30" boom
- 376 SURE STOP PRO** for 60" boom
- 377 SURE STOP PRO** for 30" boom with Snubber
- 378 SURE STOP PRO** for 60" boom with Snubber

## 3025 | downrigger weight retriever

A safety precaution for the Downrigger angler. Brings your weight in for rigging lines and releases without having to lean out over the water.



## 375-378 | SURE STOP PRO FOR ELECTRIC DOWNRIGGERS

The sure stop turns off your electric Downrigger's auto stop at the same spot every time. The tuna cord provides a secure hold for your self-locating snap and is easier on your hands when pulling your gear to the boat. The Scotty Snubber absorbs shock, provides electrical insulation and helps prevent snags (models 377 & 378). Tubing has been added to provide protection against abrasion in high wear areas.



# POWER GRIP PLUS | line release

won't snag on weeds or foul lines



1. Attach to your Downrigger Cable or Cannonball.
2. Attach your fishing line to the Power Grip release by squeezing the jaws apart and placing your fishing line between the pads. The release tension is lighter at the outer tip, and is heavier the further into the jaws you place the line.
3. The tension adjuster can be moved forward to decrease or back to increase the release tension.



1171

## POWER GRIP PLUS

1170 18"  
Monofilament leader with Cannonball Snap

1171 18"  
1172 30"  
1173 48"  
1178 60"  
Monofilament leader with Self Locating Snap

1176 6"  
1179 30"  
1191 48"  
1192 60"  
Stacker with monofilament leader and Cannonball Snap

1177 Planer Board Snap  
1190 Power Grip Plus pads (6 pcs)

## MINI POWER GRIP PLUS

1181 18"  
Wire leader with Cannonball Snap

1180 18"  
1183 30"  
Wire leader with Self Locating Snap

1182  
Planer Board Snap (4 pcs)



1170

1176



1177

1180

1181

1182



1190

# SNAPPER | line release

Fishing line is gripped between the soft pads. Variable release tension is attained by moving the line in or out of the jaws.



1160 6"  
SNAPPER RELEASE CLIP  
Stacker with monofilament leader and Cannonball Snap



1041 18"  
1049 30"  
1040 48"  
SNAPPER RELEASE CLIP  
Monofilament leader with Self Locating Snap

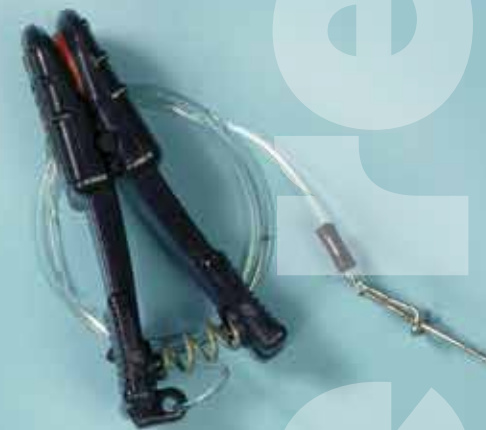

1042 18"  
SNAPPER RELEASE CLIP  
Monofilament leader with Cannonball Snap

# MINI SNAPPER | line release



1046 18"  
MINI SNAPPER RELEASE CLIP  
Monofilament leader with Self Locating Snap









1047 18"  
MINI SNAPPER RELEASE CLIP  
Monofilament leader with Cannonball Snap

# 2500 | line puller

crab & prawn trap pulling power

High torque 12V motor pulls 1 crab trap or 4 prawn traps. 120 fpm retrieval speed. Accommodates 1/4"–3/8" line. Compact size makes for easy stowing. Heavy duty stainless steel and composite construction. Easy access on/off switch. For recreational use only.

## FEATURES INCLUDED WITH LINE PULLER

-  **Mounts**  
Non-tilting Mounting Bracket
-  **Power Source**  
Marinco® 12V Plug & Receptacle (2125)
-  **Power Cord**  
Length 40"
-  **Amperage Power**  
19 amp draw at 50 lbs.
-  **Factory & Field Tested**
-  **Fully Assembled**
-  **Warranty**  
2 year



Pivoting pulley ○

Stainless steel boom ○

Easy wrap capstan ○

On/off switch ○

## TRAP-EASE

Crab and prawn trap roller for easy retrieval. Fits all Scotty post mounts.



**749**  
TRAP-EASE No mount.



**750**  
TRAP-EASE 241 Side Deck Mount.



**2515**  
**LINE PULLER STOW-AWAY BAG**  
This durable stow-away bag protects your Scotty Line Puller from the elements when not in use.



## BAIT jars

Quick lock threaded lid

Vented lid for optimal scent release but prevents sea lice entry.

**652**  
Fluorescent red 1/2 L bait jar

**651**  
White 1 L bait jar

**671**  
White 1 L vented bait jar

**657**  
Fluorescent red 1 L bait jar

**650**  
White 1/2 L bait jar

**677**  
Fluorescent red 1 L vented bait jar

**672**  
Fluorescent red 1/2 L vented bait jar

**670**  
White 1/2 L vented bait jar

# R-5

## universal rod holder

the newest to the Scotty family



The R-5 Rod Holder has been designed to securely hold your, Spinning, Baitcaster, Level Wind, Spincaster and Fly Rods with up to 15 lb test line. The adjustable 1/4" stainless steel lock bar pivots open to allow a quick effortless release of your rod. Fully adjustable lock bar tension adjusted with two number ten screws. Designed and backed by the Scotty name.



Baitcaster Reel



Spinning Reel



Spincaster Reel



Level Wind Reel



Fly Reel

30



**289**  
No mount.



**290**  
241 Side Deck Mount.



31



# ORCA

## rod holder

setting the hook is perfected

The inner sleeve opens in one smooth motion allowing your rod to be released in an instant. With one quick motion, your fishing rod is lifted straight out into the fish fighting position.

Large cradle design fits big reels

Upward motion opens rod holder

Transport lock tab

7 Locking angle positions

11 Locking position 360° post mount

1 7/8" ID accommodates large rods



**400**  
241 L Locking Side Deck Mount.



**401**  
244L Locking Flush Deck Mount.



**405**  
459 Double Ended Extender.



SMOOTH EASY OPEN ACTION



LOCKING TAB TO PREVENT ROD LOSS WHILE TRAVELING

All post mount  
Scotty Rod  
Holders are fully  
adjustable and  
interchangeable.

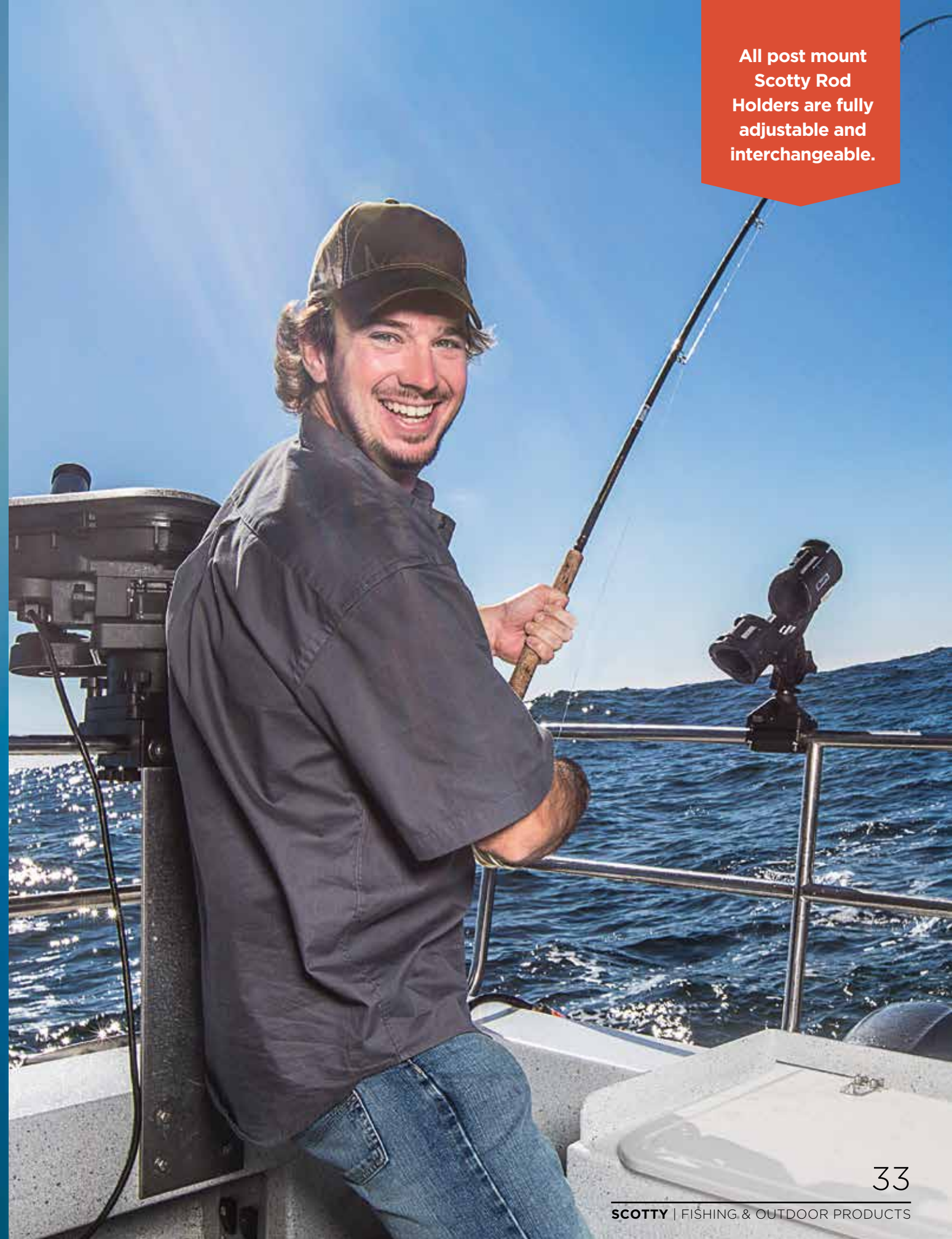

# STRIKER rod holder

designed for big game fish

Designed and built tough for Salmon, Muskie, Halibut, Sturgeon, and other big game fish. Stainless steel reinforced post with an oversized opening and easy lock/unlock collar. The inner support rotates with the rod to instantly remove and strike simultaneously.



**239**  
No mount.

## LOCKING COLLAR

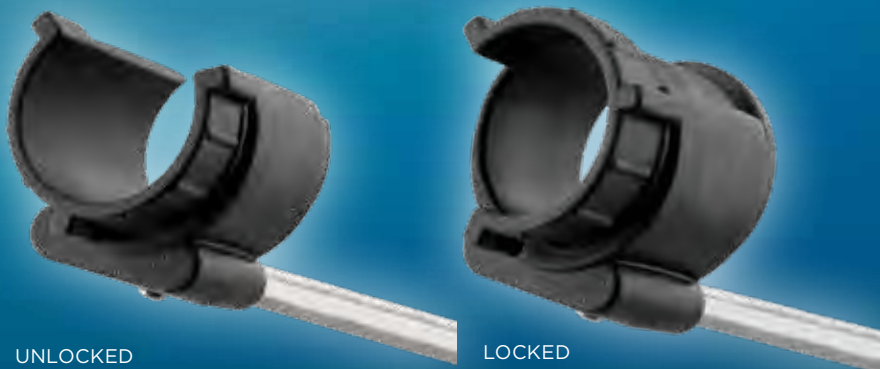

**240**  
241 Side Deck Mount.

Striker outfitted with  
423 adaptor, 1023  
Tilt up mounting  
bracket and 1026  
Swivel mount.

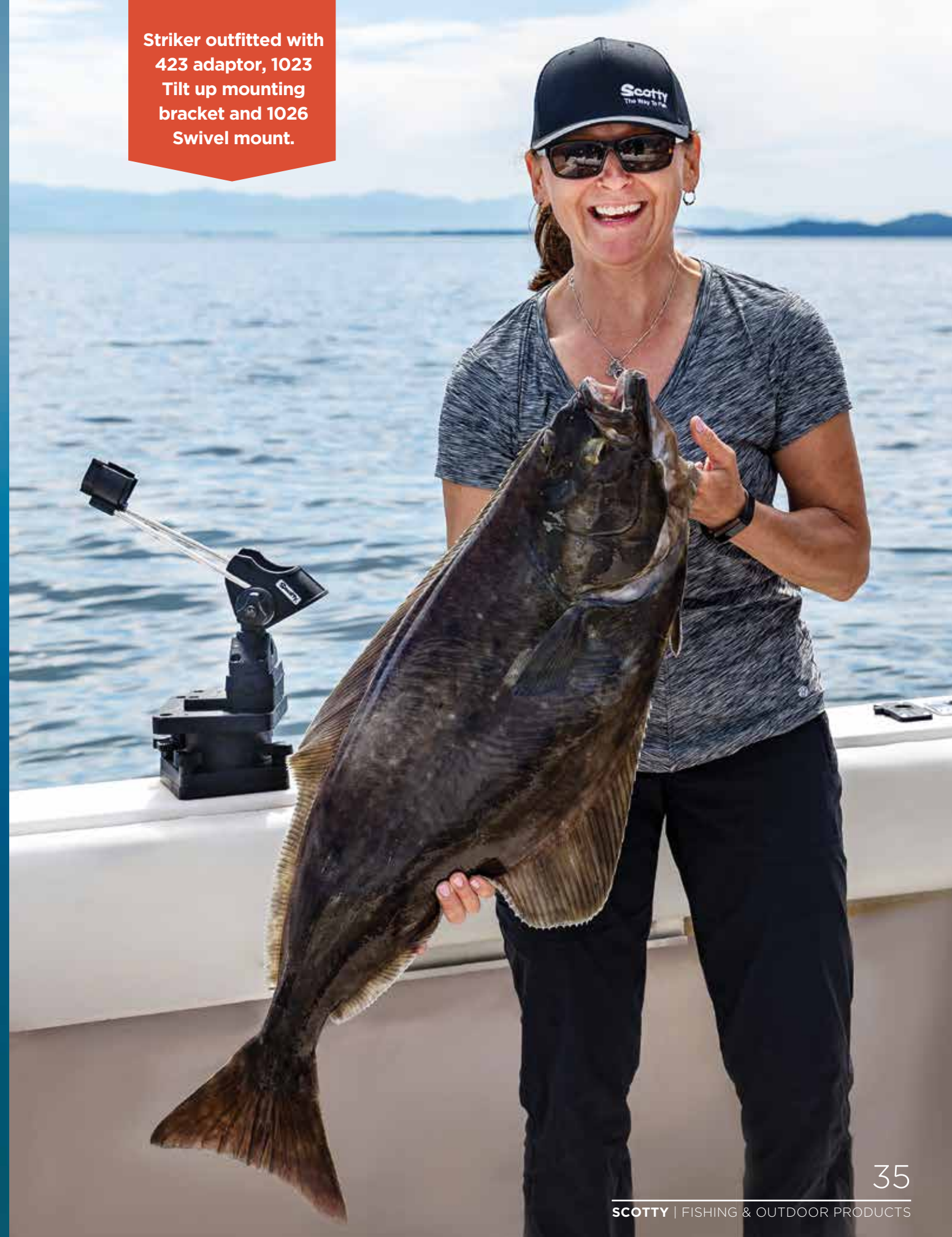

# POWERLOCK

## rod holder

our most popular rod holder

Universal cradle holds almost any reel type. Fibre reinforced engineering grade nylon provides strength, resilience and reliability.



**230**  
241 Side Deck Mount.  
○○●



**231**  
244 Flush Deck Mount.



**229**  
No mount.

### LOCKING COLLAR



UNLOCKED



LOCKED



**256**  
Triple with 257 and 241 Mounts.



**339**  
449 Clamp and 241 Mount (maximum clamp opening 2").





# the way to fish

# ROD HOLDERS

## rocket launcher

9" tube style Rod Holder made from fibre reinforced engineering grade nylon which offer strength, resilience and reliability. All post mount Scotty Rod Holders are fully adjustable up and down and with 360° of horizontal rotation. Accommodates a wide range of rod and reel setups.

Rocket Launcher Interior Diameter: 1.7"



**479**  
Comes with no mount, enabling you to choose whichever mount suits your needs separately.



**476**  
Includes 241 Combination Side Deck Mount and can be mounted on top or side of gunnel.

## rod master

Original 8" tube style holder accommodates any rod and reel combination including large rod butt tips. Fibre reinforced engineering grade nylon offers strength, resilience and reliability. All post mount Scotty Rod Holders are fully adjustable up and down and with 360° of horizontal rotation.

Rodmaster Interior Diameter: 2 1/8"



**250**  
241 Side Deck Mount.

## stainless steel rocket launcher

Tube style Rod Holder with 9" of heavy duty stainless steel jacketed composite construction. Fibre reinforced engineering grade nylon offers strength, resilience and reliability. All post mount Scotty Rod Holders are fully adjustable up and down and with 360° of horizontal rotation. Accommodates a wide range of rod and reel setups.

Rocket Launcher Interior Diameter: 1.7"



**469**  
Comes with no mount, enabling you to choose whichever mount suits your needs separately.



**470**  
Includes 241 Combination Side Deck Mount and can be mounted on top or side of gunnel.

## sidewinder

This Rod Holder was designed for fast and instant rod removal. Complete with 5/16" stainless steel for strength and durability. Soft grips protect your rod and this classic design is a favourite among anglers.



**222**  
5/16" stainless steel construction. 237 Triggerlock Mount Included.



**223**  
no mount.

## rod master II

10" tube style holder with front end reel slot and removable gimbal pin accommodating any rod and reel combination. Fibre reinforced engineering grade nylon offers strength, resilience and reliability. All post mount Scotty Rod Holders are fully adjustable up and down and with 360° of horizontal rotation.

Rodmaster II Interior Diameter: 1.85"



**349**  
No mount.



**350**  
241 Side Deck Mount.



**351**  
244 Flush Deck Mount.



**358**  
Fits 1 1/4" Scotty Downrigger boom.



**355**  
Fits 3/4" and 1" Scotty Downrigger booms.

Blainey Scott's original Rod Holder. The Side Winder has stood the test of time and is still a classic #1 choice.

# BAITCASTER SPINNING | rod holder

best selling rod holder

Holds a baitcaster reel securely in the cushioned cradle. A slot in the front of the rod holder allows for secure holding of a spinning reel. This rod holder is designed with a side mounted flange which leaves the bottom open, this allows for the rod holder to accommodate trigger grips. Rods can be secured with a soft latching strap which snaps over the top for baitcaster or under the bottom for spinning reels.



**284**  
243 1 1/4" Square Rail Mount.



**282**  
438 Gear Head and 440-4 Track.



**389**  
449 Clamp and 241 Mounts.  
Maximum clamp opening 2".



**388**  
429 Gear Head Mount Extender and 241 Mount.



**279**  
No mount.



**280**  
241 Side Deck Mount.



**281**  
244 Flush Deck Mount.

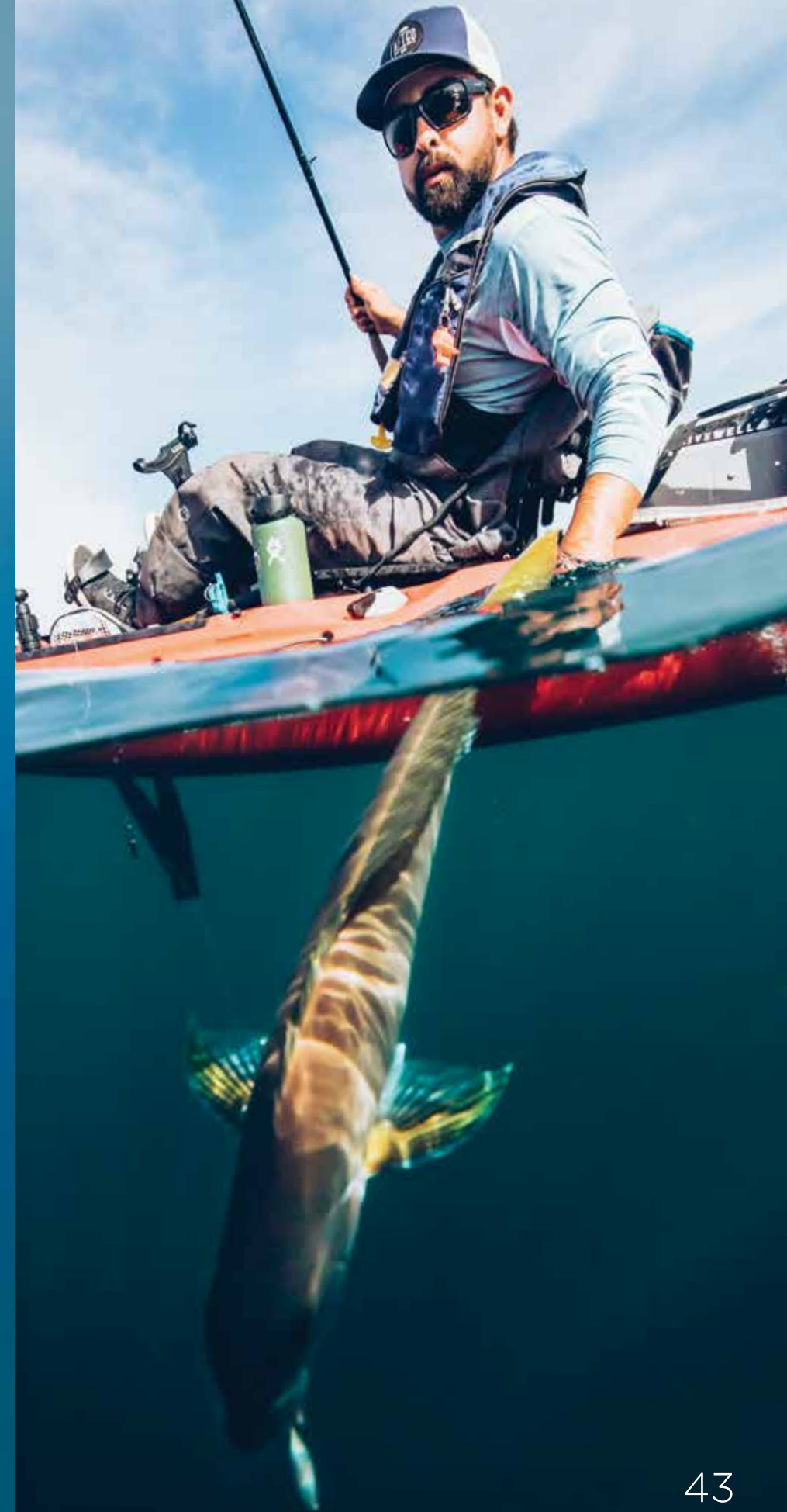

# FLY ROD

## rod holder

secure holding of your fly rod

Innovative compact design allows for hands free trolling with a Fly Rod. Your rod can be secured in the rod holder with the soft latching strap which snaps over the top. Works well with "short butt" fly rods. All post mount Scotty Rod Holders are fully adjustable.



**260**  
No mount.



**264**  
244 Flush Deck Mount.



**267**  
241 and 266 Float Tube Mounts.



**265**  
241 Side Deck Mount.

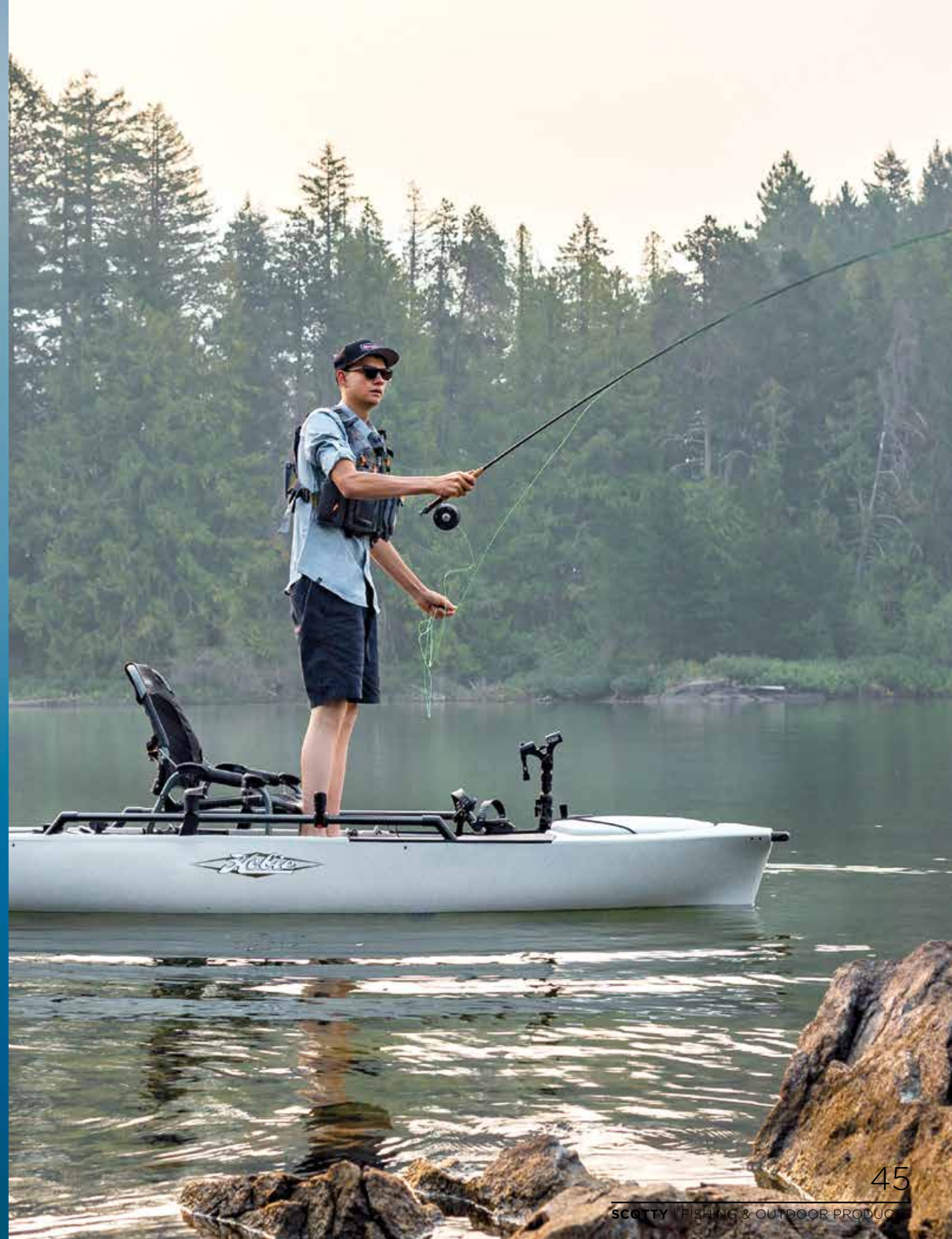

# ELECTRONIC mounts

secure your fish finder

Mounting your fish finder has never been easier with our universal fish finder mount. Designed with a multi pattern top plate to fit most popular electronic brands. The perfect mount for your 7" - 9" screens. The post mount allows you to install your screen in any of our Scotty post mount brackets. A full 360° of rotation allows you to position your screen in the perfect spot every time. Engineering grade nylon and stainless steel fasteners guarantee a lifetime of use even in the toughest conditions. Some assembly required. Accessories sold separately.



# 367 universal

sounder fish finder mount



**368**  
**UNIVERSAL SOUNDER FISH FINDER MOUNT**  
This uses a multi pattern universal top plate and the post mount design for quick removal and adjustable rotation.



**268**  
**FLOAT TUBE FISH FINDER MOUNT**  
Adapt a fish finder to your float tube or pontoon boat. Includes transducer bracket and 6' strap.



**367**  
**UNIVERSAL SOUNDER FISH FINDER MOUNT**  
The perfect mount for your 7"-9" screens.



**272**  
**SWIVEL FISH FINDER MOUNT**  
Mount only.



**269**  
**SWIVEL FISH FINDER MOUNT**  
241 Side Deck Mount.

Pair your electronics with the strongest mounts on the market. All of our products are made under one roof. This gives us the ability to produce the highest quality you have come to trust.





# TRANSDUCER

## mount

Designed for kayaks and small boats

Made from high strength composite materials. Adjustable arms allow for multiple depths and angles. Collapses easily for storage. 415 slip discs for micro adjustments.



**140**  
TRANSDUCER ARM  
412 Post and 241 Side Deck Mount.

**141**  
TRANSDUCER ARM  
438 Gear Head and 440-4\" Low Profile Track.

# CAMERA

## mount

full rotation



**135**  
CAMERA MOUNT  
This mount is fully twistable, turnable, rotatable and best of all, instantly portable. Locks down a sport or standard camera without needing a special adaptor. Also included is a rail mount.

# BALL mounts

a system designed for full range of motion

The ball mounting system design enables a smooth, full range of motion. The corrosion proof construction provides a long service life in both fresh and salt water applications.



**158**  
**1" BALL ACCESSORY**  
Adapt your Scotty low profile track to our 1" ball mounting system.



**168**  
**1.5" BALL ACCESSORY**  
Adapt your Scotty low profile track to our 1.5" ball mounting system.



**150**  
**1" BALL MOUNT**  
Universal Mounting Plate.



**159**  
**1" BALL ACCESSORY**  
Adapt your Scotty post mount to our 1" ball mounting system.



**169**  
**1.5" BALL ACCESSORY**  
Adapt your Scotty post mount to our 1.5" ball mounting system.



**151**  
**1" BALL MOUNT**  
Gear Head & track.



**162**  
**1.5" BALL MOUNT**  
Gear Head, post & Side Deck Mount.



**163**  
**1.5" BALL MOUNT**  
Fish Finder & Universal Mounting Plate designed for use with 7-9" screens.



**152**  
**1" BALL MOUNT**  
Gear Head, post & Side Deck Mount.

# ball mounting system

# 173 | 2.25" ball mount

for large fish finders

Arrange your fish finder at the perfect angle on your watercraft with this heavy duty 2.25" ball mount. Designed for 10"- 12" fish finders. Pre fabricated holes on the top plate allow easy installation of your gimbal mount bracket. The square base securely fastens with 1/4" bolts. 2.25" ball design has superior strength and reliable holding power. Constructed using engineering grade Nylon and stainless steel fasteners to last a lifetime.

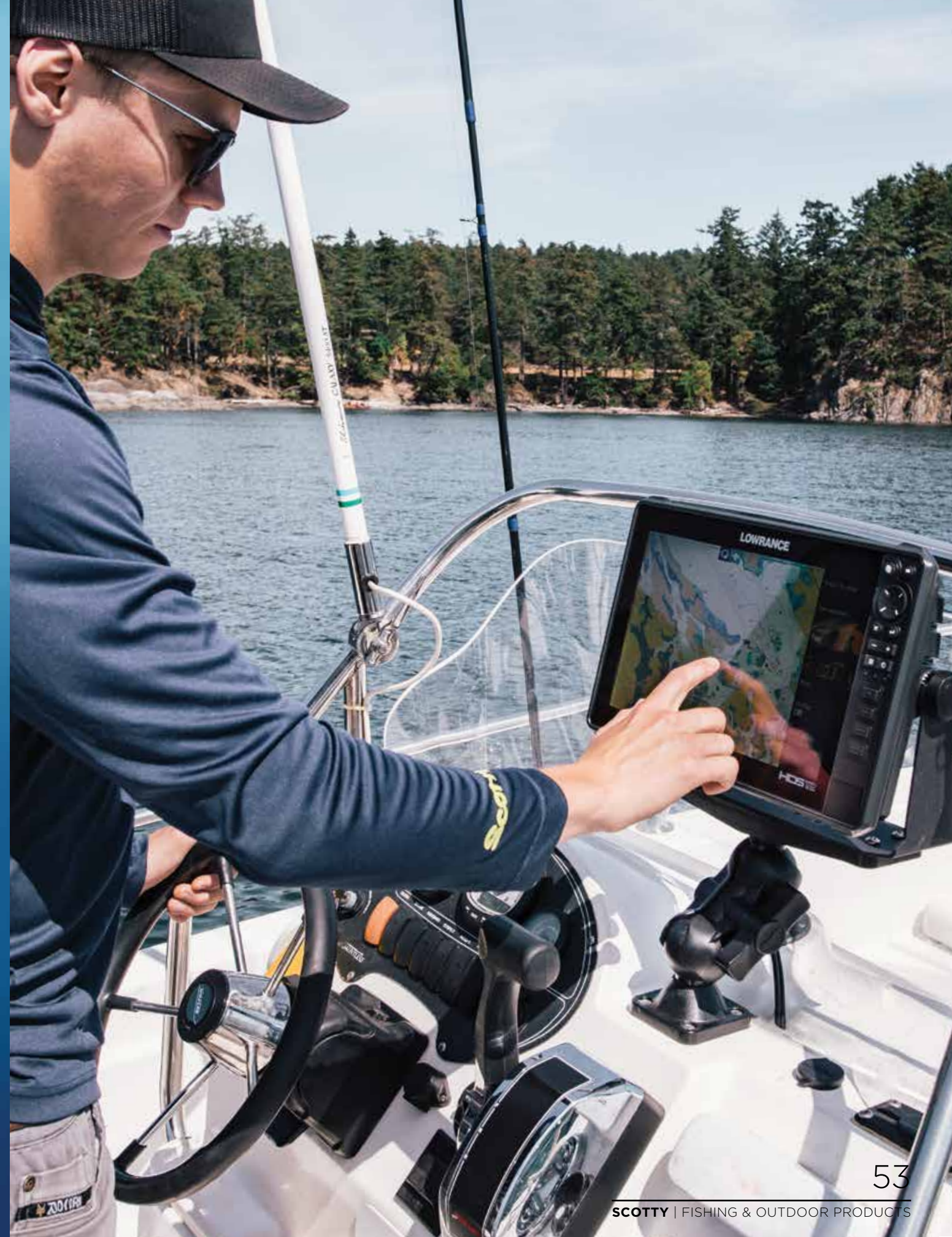

# 343 | locking gunnel track mount

Purpose-built for boats with integrated gunnel tracks, the 343 securely attaches to your vessel without the need to drill holes, or carry tools. This simple, intuitive design allows you to quickly add, remove, or reposition the mount anywhere on the boat, from bow to stern.

A dependable lock to keep gear solidly in place, and a push-button release makes changes and removal fast and easy. Compatible with all of your favourite post mount Scotty accessories.

No tools or drilling holes required

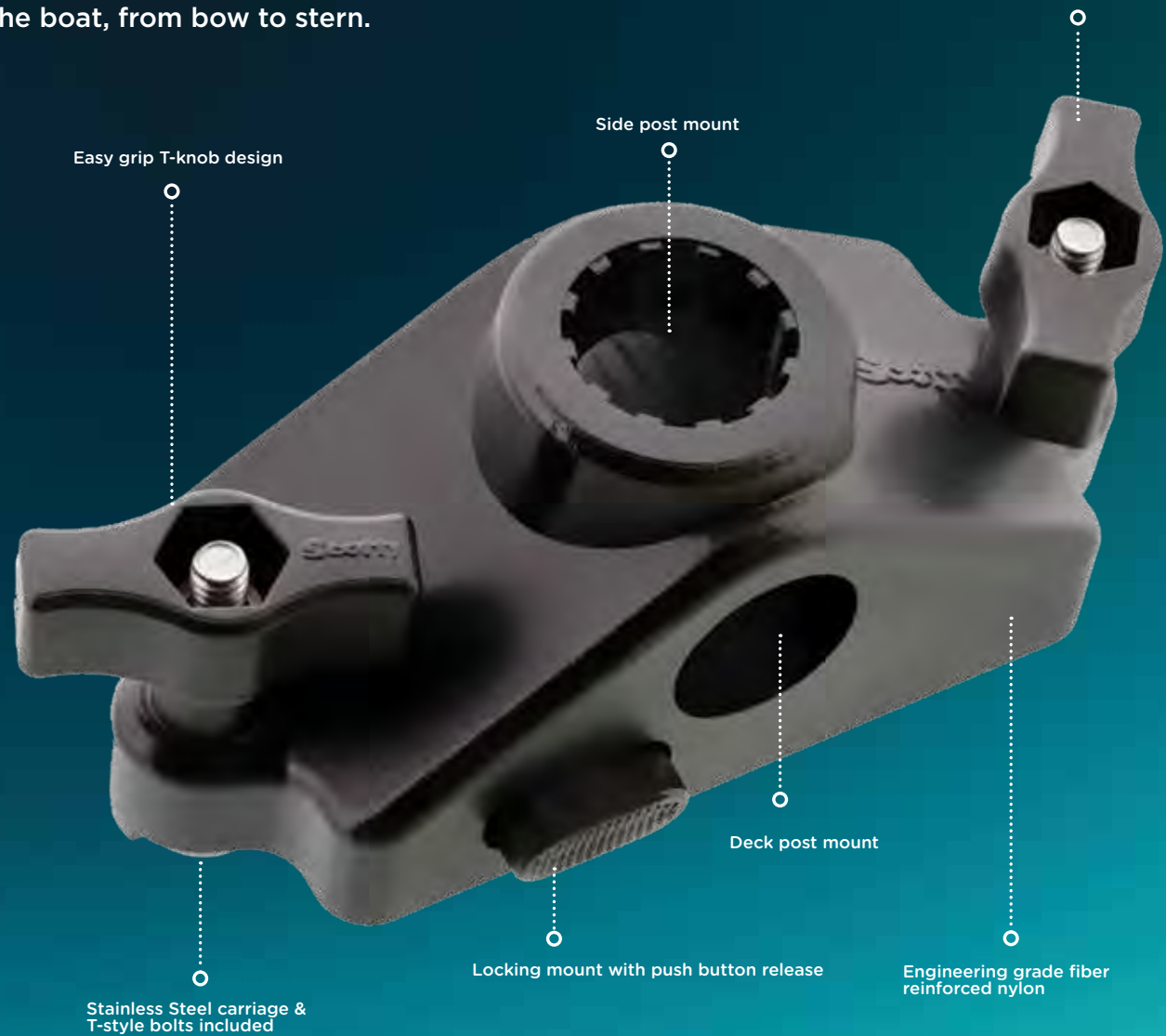

STAINLESS STEEL CARRIAGE BOLT



STAINLESS STEEL T-STYLE BOLT





**241**  
**SIDE DECK MOUNT**  
Can be mounted on top or side of your gunnel.



**241L**  
**LOCKING SIDE DECK MOUNT**  
A 241 mount with an easy to use lock and unlock push button system.



**344**  
**ROUND FLUSH DECK MOUNT**  
Sealed base for watertight applications.

## adaptors



**237**  
**TRIGGERLOCK**  
Designed for 222 Sidewinder Rod Holder.



**238**  
**RAIL MOUNT ADAPTOR**  
Works in conjunction with 237 Triggerlock Mount (7/8" and 1" round rails).



**441**  
**BACKING PLATE**  
Adds structural support when attaching a Side Deck or Flush Deck Mount to a thin-walled watercraft.



**444**  
**COMPACT THREADED DECK MOUNT**  
Use on gunnels up to 2" thick. Base cap for watertight applications.



**244**  
**FLUSH DECK MOUNT**  
Sealed base for watertight applications.



**244L**  
**LOCKING FLUSH DECK MOUNT**  
Locks and unlocks your post mount product easily by sliding a lever.



**242**  
**RAIL MOUNT ADAPTOR**  
Works with 241 Side Deck Mount (7/8" and 1" round rails).



**340**  
**TRACK ADAPTOR**  
Convert your 3 1/2" track into a Scotty Post Mount. 241 Side Deck Mount required.



**423**  
**DOWNRIGGER ROD HOLDER ADAPTOR**  
Convert your 1023 tilt-up mounting bracket into a rod holder mount. 241 Side Deck Mount required.



**243**  
**SQUARE RAIL MOUNT**  
Fits 1 1/4" rail.



**245**  
**ROUND RAIL MOUNT**  
Fits 1 1/4" rail.



**287**  
**ROUND RAIL MOUNT**  
Fits 7/8" rail.

## TRIPLE mounting systems

Designed to be a multi-functional rod holder or accessory platform for any watercraft.



**257**  
**TRIPLE MOUNT**  
241 Side Deck Mount.



**362**  
**TRIPLE MOUNT**  
Fixed Mount.



**248**  
**OARLOCK MOUNT**  
Use the oarlock mount on your row boat to mount any Scotty post mount rod holder or accessory.



**449**  
**CLAMP MOUNT**  
Fully portable mounting option for all Scotty post mount rod holders and accessories, maximum clamp opening 2".



**433**  
**COAMING/GUNNEL CLAMP MOUNT**  
Position your rod holder or accessory virtually anywhere on the lip of your kayaks coaming or boat gunnel, maximum clamp opening 1 1/2".



# LOW PROFILE track

top load design for quick and easy use

Made from corrosion proof high strength composite materials that will last a lifetime. Use the 438 Gear Head Track Adaptor to mount all of your favourite rod holders and accessories.

**440-1**   
**1" LOW PROFILE TRACK**  
 Dimensions: 7" L x 1 3/4" W x 3/8" H  
 Bolting Dimensions: 1 3/4" x 1 1/8"

**440-4**   
**4" LOW PROFILE TRACK**  
 Dimensions: 3 1/2" L x 1 3/4" W x 3/8" H  
 Bolting Dimensions: 1 3/4" x 1 1/8"

**440-8**   
**8" LOW PROFILE TRACK**  
 Dimensions: 10 3/4" L x 1 3/4" W x 3/8" H  
 Bolting Dimensions: 1 3/4" x 1 1/8"



311 CUP HOLDER • 438 GEAR HEAD • 440-1 TRACK



290 R-5 ROD HOLDER • 438 GEAR HEAD • 440-4 TRACK

# GEARHEAD track adaptor & mounts

Quick and easy, drop and lock system. Allows you to secure and reposition your rod holder or accessory with just a twist. Fits all Scotty post mount rod holders and accessories.

**426**  
**SIDE SLIDE TRACK ADAPTOR**  
 Our unique Track Adaptor allows you to securely fasten your favourite post mount product to a side mounted track.



**428**  
**GEAR HEAD MOUNT**  
 Use in conjunction with any of our height extenders to bring your rod or accessory closer to you.



**438**  
**GEAR HEAD TRACK ADAPTOR**  
 Use the Track Adaptor with the 440 Low Profile Track for quick and easy installation and removal of your favourite Scotty post mount product.



**436**  
**STAND UP PADDLE BOARD LEASH PLUG ADAPTOR**  
 The adaptor attaches to your SUP pre-installed leash plug with a stainless steel J Hook. Accepts all post mount rod holders and accessories.



135 CAMERA MOUNT • 438 GEAR HEAD • 440-8 TRACK

279 BAITCASTER • 438 GEAR HEAD • 440-8 TRACK

# INFLATABLE accessories

fishing essentials



**838**  
Sea Light



**793**  
Throw Bag



**311**  
Cup Holder



**279**  
Baitcaster Spinning Rod Holder



**750**  
Trap-ease



**140**  
Transducer Mount



**439**  
Track adaptor

**438**  
Gear Head Track adaptor



**290**  
R-5 Rod Holder



**341**  
Glue on Mount



**276**  
Anchor Lock



**443**  
3" Glue/stick on Mount- Flexible D-Ring



**445**  
2" Glue/stick on Mount 438 Gear Head

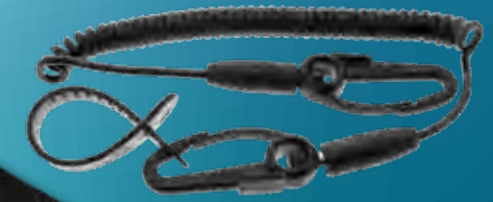

**130**  
Paddle Leash



**545K**  
25½" O.A.L. Kayak Pump



**448**  
3" Glue/stick on Mount 438 Gear Head



**1073**  
Laketroller



**779**  
Small Vessel Safety Kit

# 439 track adaptor

for glue on pad

Our track adaptor allows you to mount your favourite track accessories to your inflatable watercraft's pre installed 341 mounts.

Simply fasten the track to your 341 mount with the supplied 1/4 - 20 x 1/2" stainless steel bolts. Slide and lock our 438 gear head adaptor or ball mount onto the track.



- Smooth low profile for snag free lines
- Top load design allows for easy installation
- Engineering grade fibre reinforced nylon
- 1/4- 20 x 1/2" stainless steel fasteners

**Please note:**  
Only use 1/4 - 20 x 1/2" bolts when fastening the track to your 341 glue on pad.



**279 BAITCASTER • 438 GEAR HEAD  
439 TRACK • 341 GLUE/ON MOUNT**



**368 MOUNT • 438 GEAR HEAD  
439 TRACK • 341 GLUE/ON MOUNT**



**368 MOUNT • 438 GEAR HEAD  
439 TRACK • 341 GLUE/ON MOUNT**



**135 CAMERA MOUNT • 438 GEAR HEAD • 163 BALL MOUNT  
439 TRACK • 341 GLUE/ON MOUNT**



**279 BAITCASTER • 438 GEAR HEAD • 163 BALL MOUNT  
439 TRACK • 341 GLUE/ON MOUNT**



# BOATING | & fishing accessories



**310**  
CUP HOLDER & BUTTON  
Cup Holder **A** and Gunnel mount **C**.

**311**  
CUP HOLDER, POST & BUTTON  
Cup **A**, Post **B** and Gunnel mount **C**.



**215**  
REPLACEMENT NET BAG



**3010**  
Snap Hook Key Chain.  
●●●●●●●●



**415**  
SLIP DISKS  
Allows you to make micro adjustments to your rod holder or any Scotty post mount products.



**414**  
OFFSET GEARS  
Doubles your rod holder positions for ultimate versatility.



**210**  
NET MINDER  
A quick release and tangle free system for netting fish.



**412**  
REPLACEMENT POST  
The replacement post fits all Scotty post mount rod holders.



**990**  
KNIFE SHARPENER  
Safe and easy to use. Rotatable carbide blades included.



**125**  
TUMBLER CUP  
Holds up to 14 oz. dishwasher safe.

# MOUNTS | glue/stick on

includes 3M™ VHB™ Tape

3M™ VHB™ Tapes utilizes modified acrylic adhesive on both sides of a very conformable, adhesive foam core.



**443**  
3" GLUE/STICK ON MOUNT  
Flexible D-Ring.



**445**  
2" GLUE/STICK ON MOUNT  
438 Gear Head.



**342**  
GLUE/STICK ON PADDLE CLIP



**448**  
3" GLUE/STICK ON MOUNT  
438 Gear Head.



**341**  
GLUE ON MOUNT



All these products are ideal for inflatable watercrafts, paddle boards and kayaks.

# EXTENSIONS & adaptors

Extend and adapt all of your Scotty post or spline mount rod holders and accessories. Always have your fishing rod within reach and your favourite accessories at the perfect location.

**259**  
height extender  
6½" long

**254**  
height extender  
8½" long

**254M**  
mini extender  
4¼" long

**412**  
post

**459**  
double ended  
extender  
9½" long

**453**  
gimbal adaptor  
gear head

**2028**  
gimbal mount  
1½" diameter 9" long

**253**  
gimbal  
mount

**459M**  
mini double  
ended extender  
5½" long

**429**  
gear head  
mount extender

# BAIT BOARD & accessory tray

**135** camera mount



**990** knife sharpener



**310** cup holder



**455** bait board & accessory tray



**241** side deck mount



# ANCHOR LOCK & kit



**278** ANCHOR LOCK  
Fixed mount.

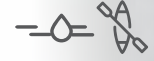

**276** ANCHOR LOCK  
241 Side Deck Mount.

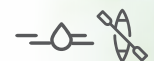

**277** ANCHOR LOCK  
244 Flush Deck Mount.

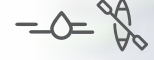

**797** ANCHOR KIT  
Anchor Kit for still water use only



# BOATING accessories

**101**  
**OAR COLLARS**  
Made from polyethylene. Quick and easy to install. 1 3/4" inside dia. can be trimmed to fit smaller oars (fasteners included).

**102**  
**STRONGBACK OARLOCKS**  
2 1/2" Standard Oar.

**104**  
**STRONGBACK OARLOCKS**  
1 3/4" Small Oar.

**103**  
**OARLOCK POSTS**  
Adapt your post mount to a 1/2" oarlock socket.

**425**  
**ROD BUTT CUSHION**  
The next best thing to a fighting belt. The Rod Butt displaces the pressure of your rod while playing fish.

**327**  
**FENDER RINGS**  
Use to attach a fender to your Scotty post mounts (2 pcs).

**132**  
**EXTRA LONG GRIP MOUNTING RIVETS**  
These structural rivets are an excellent solution for mounting hardware where you don't have access to the back side of a mount (10 pcs).

**416**  
**ROD BALANCER/REST**  
Non-resistance approach encourages more efficient and successful strike to hook-sets when fishing.

**133**  
**WELL NUT MOUNTING KIT**  
Securely fasten a multitude of products onto thin walled structures with ease. Available in 4 or 16 pack options (fasteners included).

**590**  
**SNAP HOOKS**  
Our nylon clips are a perfect solution for attaching items to your watercraft (6 pcs).

**300BK**  
**TARP CLIPS**  
Quick and easy to use design with powerful locking jaws for the ultimate hold (4 pcs).

**301BK**  
**TARP CLIPS BULK/BUCKET**  
Our patented jaw locking feature with a quick push button release (60 pcs).



# PADDLE SPORT | accessories



**136 PADDLE CLIP**  
Permanently mount to your watercraft with 2 x #6 screws.



**342 GLUE/STICK ON PADDLE CLIP**  
Easily clip your paddle to your inflatable watercraft with 1" x 6" PVC pad.



**130 PADDLE LEASH**  
Secure your paddle or fishing rod.



**341 GLUE-ON MOUNT**  
Designed to be used with our 241/241L and 439 mounts (7" x 9" pad)



**436 STAND UP PADDLE BOARD LEASH PLUG ADAPTOR**  
The adaptor attaches to your stand up paddle board's pre-installed leash plug with a stainless steel J Hook. Accepts all post mount rod holders and accessories.



**445 2" GLUE/STICK ON MOUNT**  
438 Gear Head.



# 302 | kayak stabilizer

security & stability

Feel secure and stable while fishing with Scotty Stabilizers attached to your kayak. Easily inflatable bladders offer over 30 pounds of extra buoyancy and our unique assembly system makes installation and removal a breeze. The pontoons are made from a rugged PVC with thick outer shell for extra durability.



**302 KAYAK STABILIZER**  
Over 30 lbs. of extra buoyancy. Our unique design makes installation and removal quick and easy.

visit page 79 for safety products

## CONTAINS

- 2 Inflatable Pontoons
- 2 Anodized Aluminum Stabilizer Arms (28")
- 2 Baitcaster Spinning Rod Holders (279)
- 4 Locking Side Deck Mounts (241L)

- Stabilizer Arm Length:** 28"
- Inflatable Pontoon Length:** 30"
- Inflatable Pontoon Diameter:** 8"
- Zipper Opening:** 30" long x 8" diameter

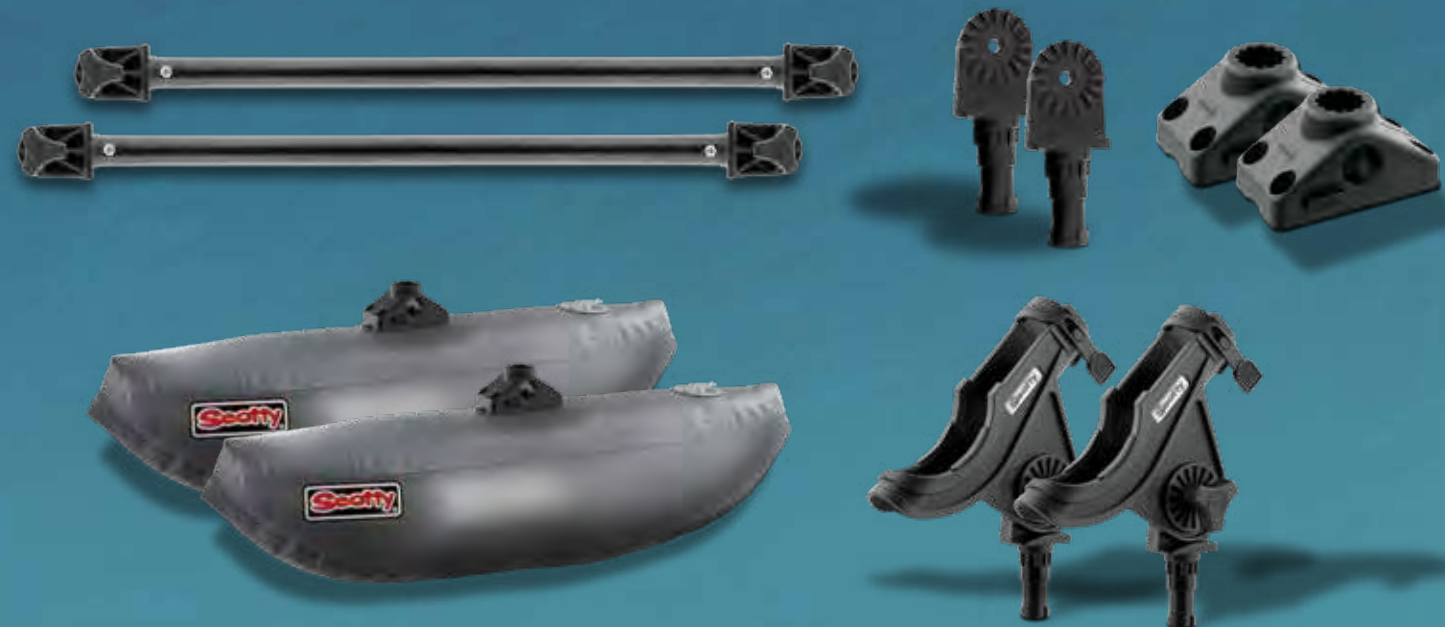

Not recommended for surf launching or use in extreme conditions.



**282**  
Baitcaster spinning rod holder



**429**  
Gear Head Mount Extender



**133**  
Well Nuts



**135**  
Camera Mount



**343**  
Locking Gunnel Track Mount



**290**  
R-5 Universal Rod Holder



**367** Universal Fish Finder Mount



**311**  
Cup Holder

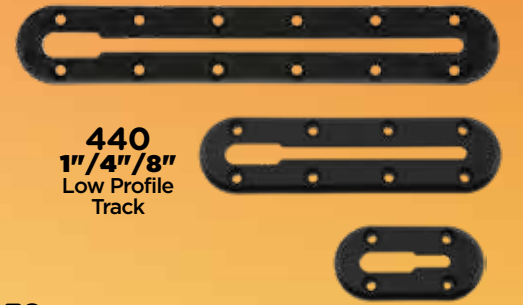

**440**  
1" / 4" / 8"  
Low Profile Track

**438**  
Gear head track adaptor



**141**  
Transducer Mount



**838**  
Sea Light



**150**  
1" Ball Mount



**257**  
Triple Mount



**368**  
Universal Fish Finder Mount



**835**  
Sea Light



**793**  
Throw Bag



**151**  
1" Ball Mount



**455**  
Bait Board & Accessory Tray



**162**  
1 1/2" Ball Mount



**163**  
1 1/2" Ball Mount



**797**  
Anchor Kit

# 111 | kayak fishing

starter pack

Fishing essentials for outfitting your Kayak. The Kayak Starter Pack includes a 282 Baitcaster Spinning Rod Holder with Gear Head & Track, 438 Gear Head Track Adaptor, 440-4 4" Low Profile Track, 311 Drink Holder, 136 Paddle Clip and 455 Baitboard & Accessory Tray.

(Not intended for use with Inflatable Kayaks)

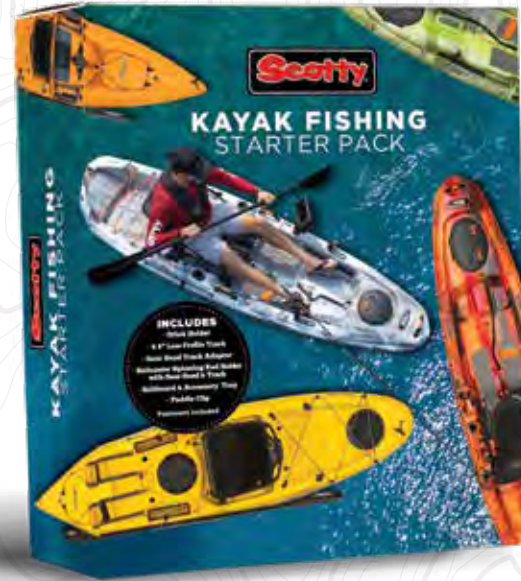

**282**  
**BAITCASTER SPINNING ROD HOLDER WITH GEAR HEAD & TRACK**  
 Holds a Baitcaster reel securely in the cushioned cradle.

**438**  
**GEAR HEAD TRACK ADAPTOR**  
 Slide the Gear Head into any of our 440 series track, twist the gear head clockwise to securely lock.

**440-4**  
**4" LOW PROFILE TRACK**  
 Low Profile Track-top load design allows for quick and easy setup.

**311**  
**DRINK HOLDER**  
 Fits cans, coffee mugs and insulated sleeves.

**136**  
**PADDLE CLIP**  
 Holds your paddle, net, gaff & boat hook.

**455**  
**BAITBOARD & ACCESSORY TRAY**  
 Exterior tray walls let you cut bait and prep lures.

Stainless steel fasteners Included:  
 #10 x 5/8".



## Sea-Light

ACR detachable, fully sealed LED C-Light™, bright 20 Lumen White LED for location assistance during emergencies. Easy twist ON/OFF activation that is waterproof tested. Impact resistant construction and is USCG/ SOLAS approved. C-Light™ is easily removed and can be attached to life jackets, backpacks, or hang from a pocket. C-Light™ requires two AA 1.5V batteries (batteries not included) C-Light™ has an extensive and continuous operating life for over 30 hours.

### 835 SEA-LIGHT WITH SUCTION CUP MOUNT

A non-permanent safety addition that is perfectly portable for kayaks and small watercraft. Designed to meet the demands of the sea but also ideal for within a vehicle, for camping and whenever a reliable high efficient light is needed. Includes versatile suction cup mount for use in both salt and fresh water.

### 838 SEA-LIGHT WITH POLE & BALL MOUNT

The Scotty Ball System joint design enables a smooth and complete full range of motion for the Sea-Light. The corrosion proof construction of this system provides a long service life in both fresh and salt water applications as it is designed with stainless steel fasteners and a stainless pole. Base Mount Dimensions: 2 1/4" x 2 1/4" Overall Height: Stands 41" tall Sea-Light Pole Diameter: 1/2". Post Mount included.



**130**  
PADDLE LEASH



**779**  
SMALL VESSEL SAFETY EQUIPMENT



**780**  
SAFETY WHISTLE  
**784**  
PEALESS SAFETY WHISTLE



**793**  
RESCUE THROW BAG

## Pumps



**545K**  
25 1/2" O.A.L.  
KAYAK PUMP



**544**  
18 1/2" O.A.L.  
HAND PUMP



**544K**  
18 1/2" O.A.L.  
KAYAK PUMP



**545**  
25 1/2" O.A.L.  
HAND PUMP



**548**  
39" O.A.L.  
HAND PUMP



# Jordan-Scotty

## FISH EGG INCUBATOR SYSTEMS



• Locking tooth design helps hold the trays in place while in water

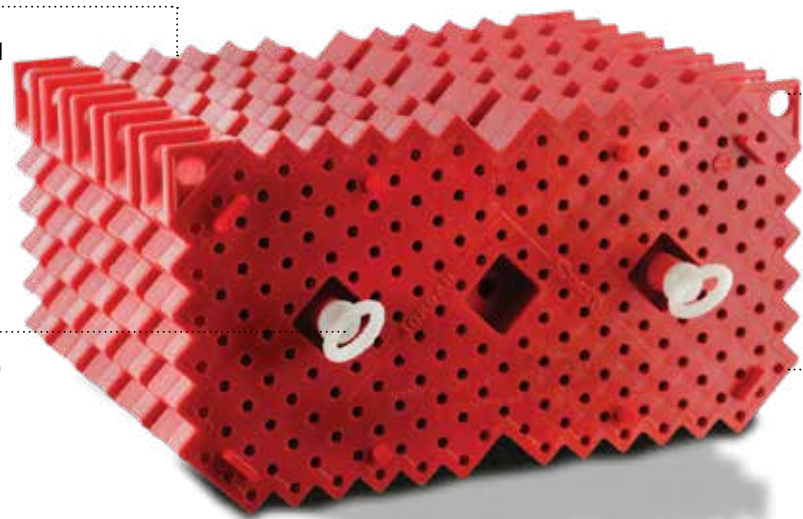

• 12" nylon tie bolt, holds up to five sets at a time

• Hold tabs for anchoring

• Nestling tabs leave space between trays for water flow



### Checking your Results and Removing Incubator

When removing the incubator, care should be taken to not disturb the gravel, as this is where the fry are hidden.

Once removed, the incubator can be opened to reveal the success of the hatch rate. Wash incubators thoroughly and dry before storage. Store in a dark, dry place. With proper care, the Jordan/Scotty Incubator units can be used season after season.

If possible, please submit results of your project to your local Fisheries Department or hatchery, as well as Scotty. We would appreciate any information or report you can provide in order to log success rates and use of these units.

### History and Design

The original incubator prototype was designed and tested by Mr. Fred Jordan, a Salmonid Technician for many years. He conceived the idea for stream enhancement during the 1980's. The success of his early experiments with this unit led to research, development and further design of the incubator by Scotty Manufacturing Ltd. Sidney, BC. This unit is extremely efficient and very compact. It is simple to use, durable, cost effective and practical, making it an excellent addition to enhancement projects.

The Jordan/Scotty Fish Egg Incubator is a scientifically designed and tested plastic incubation unit and was developed to provide an efficient aid in the stream incubating of fish eggs. The unique design either eliminates or minimizes most of the problems experienced by natural spawning. Fungus infection is virtually eliminated and eggs are protected from predators and silt suffocation. Testing and usage indicates that survival rates from egg to fry is often better than 65-95% as compared to natural spawning survival rates of between 5-20%.

In nature, high egg loss rates can easily be caused by poor fertilization, unsuccessful egg burial, fungus from dead eggs spreading to healthy eggs, attrition by predators, and silt suffocation. The Jordan-Scotty Fish Incubator addresses these issues and others. Egg quality can be checked during the loading process and all eggs are fertilized before loading. Eggs are quarantined from each other during development, limiting the spread of disease and fungal infection. Eggs are safe from predators and alevin are safely contained until their yolk sac have been absorbed, increasing survival rates.

### Where and When to Obtain Eggs

Contact your local Department of Fisheries & Oceans or similar agency. In Canada, contact the DFO Community Advisor. The disposition of salmonid eggs is carefully supervised and controlled by DFO to ensure that all enhancement activities meet are requirements and conform to the department standards.

Protocols regarding the transfer of eggs must be approved by the federal-provincial Introductions and Transfers Committee. In British Columbia, a list of the community advisors in your area can be obtained by contacting the Habitat Enhancement Branch.

**Department of Fisheries & Oceans Community Involvement Habitat Enhancement Branch**

**400-555 West Hastings Street  
Vancouver, BC Canada  
1-604-666-6614**

### Where to Obtain Jordan Scotty Incubator Systems

These Egg Incubator units are available at a nominal price to cover minimum raw materials and labour costs. Incubators can be purchased from:

**Scotty Manufacturing Ltd.**

1-800-214-0141  
incubator@scotty.com



**STAY** | **connected**  
with our social media channels

Check in with Scotty's Social Media Channels to learn about new products, promotions, give-aways, news and information. To submit your photos send them to [socialmedia@scotty.com](mailto:socialmedia@scotty.com)

 @scottyfishingproducts  
**@scottyfishingproducts**



  scottyproducts  
**scottyproducts**

 @scottyproducts  
**@scottyproducts**



  Scotty Fishing & Outdoor Products  
**Scotty Fishing & Outdoor Products**

**the way to fish<sup>®</sup>**

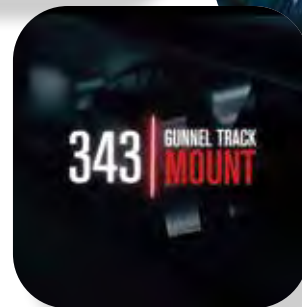
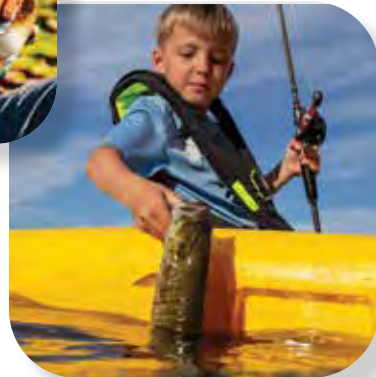

**SCOTTY FISHING & OUTDOOR  
PRODUCTS**

2065 Henry Ave West  
Sidney, British Columbia  
Canada V8L 5Z6

**PHONE** 250 656 8102  
**TOLL FREE** 1 800 214 0141  
**FAX** 250 656 8126  
**EMAIL** [scotty@scotty.com](mailto:scotty@scotty.com)



[www.scotty.com](http://www.scotty.com)

